



USER'S GUIDE

2553/2553E

Three-Phase

Power Analyser

Warranty

The Vitrek instrument is warranted against defects in material and workmanship for a period of two years after the date of purchase. Vitrek agrees to repair or replace any assembly or component (except batteries) found to be defective, under normal use, during the warranty period. Vitrek obligation under this warranty is limited solely to repairing any such instrument which in Vitrek sole opinion proves to be defective within the scope of the warranty, when returned to the factory or to an authorized service center. Transportation to the factory or service center is to be prepaid by the purchaser. Shipment should not be made without prior authorization by Vitrek.

The warranty does not apply to any products repaired or altered by persons not authorized by Vitrek, or not in accordance with instructions provided by Vitrek. If the instrument is defective as a result of misuse, improper repair, or abnormal conditions or operations, repairs will be billed at cost.

Vitrek assumes no responsibility for its product being used in a hazardous or dangerous manner, either alone or in conjunction with other equipment. Special disclaimers apply to this instrument. Vitrek assumes no liability for secondary charges or consequential damages, and, in any event, Vitrek'S liability for breach of warranty under any contract or otherwise, shall not exceed the original purchase price of the specific instrument shipped and against which a claim is made.

Any recommendations made by Vitrek or its Representatives, for use of its products are based upon tests believed to be reliable, but Vitrek makes no warranties of the results to be obtained. This warranty is in lieu of all other warranties, expressed or implied, and no representative or person is authorized to represent or assume for Vitrek any liability in connection with the sale of our products other than set forth herein.

Instrument Serial Number: _____

Document Part Number: MO-2553-M Revision C

Print date: February 21, 2000

Copyright

Copyright© 1999 Vitrek All rights reserved.

All rights reserved. No part of this publication may be reproduced, transmitted, transcribed, stored in a retrieval system, or translated into any language in any form without prior written consent from Vitrek. This product manual is copyrighted and contains proprietary information, which is subject to change without notice. The product's displays and manual text may be used or copied only in accordance with the terms of the license agreement.

XITRON TECHNOLOGIES is a trademark of Vitrek. All other trademarks or registered trademarks are acknowledged as the exclusive property of their respective owners.

In the interest of continued product development, Vitrek reserves the right to make changes in this guide and the product it describes at any time, without notice or obligation.

Vitrek

12169 Kirkham Road

Poway, CA 92064

(858) 689-2755

info@vitrek.com

Contents

INTRODUCTION	11
Scope	11
Features	12
FUNCTIONAL DESCRIPTION	13
Theory of Operation	13
Interfaces	15
Front Panel	15
Parallel Printer	15
IEEE488	16
USING THE POWER ANALYSER	17
Setting Up	17
Front Panel	18
Rear Panel Connections	19
Starting the Power Analyser	20
Configuring the Power Analyser	20
Measurement Connections	24
Using Internal Current Transducers	24
Internal Transducer Connections for Test	25
Using External Current Transducers	27
External Transducer Connections for Test	28
SEQUENCE OF DISPLAY SCREENS	29
Using the Diagrams	29
Diagrams	30

VIEWING RESULTS	35
Display Screens	35
Basics Group	36
Harmonics Group	41
Waveforms Group	44
History Group	46
PRINTING RESULTS	51
Sample Printouts	51
CALIBRATION	65
Removing DC Current Offsets	65
Calibrating the Power Analyser	67
Calibration Procedures	67
Voltage Calibration	69
Current Calibration	72
Calibration Faults	75
APPENDIX A - PHYSICAL SPECIFICATIONS	77
Temperature & Humidity	77
Size & Weight	77
Power Input	77
APPENDIX B - MEASUREMENT SPECIFICATIONS	79
Power Source Capabilities (Option E only)	79
Input Signal Capabilities	79
Input Burden	80
Measurement Accuracy	80

Figures

Figure 1. Bench Type Power Analyser	17
Figure 2. Front Panel detail	18
Figure 3. Rear Panel detail	19
Figure 4. Startup screen	20
Figure 5. Setup Index screen with INTERFACES/DATE/TIME selected	20
Figure 6. The Interface Setup screen	21
Figure 7. Setup Index screen with MEASUREMENTS & WIRING selected	21
Figure 8. The Measurements & Wiring Setup screen	22
Figure 9. Setup Index screen with CURRENT INPUTS selected	22
Figure 10. The Current Input Setup screen	23
Figure 11. Setup Index screen with PRODUCT OPTIONS FITTED selected	24
Figure 12. The Product Options Fitted screen	24
Figure 13. 1 ϕ 2-Wire Connections diagram	25
Figure 14. 1 ϕ 3-Wire Connections diagram	25
Figure 15. 3 ϕ 3-Wire Connections diagram	26
Figure 16. 3 ϕ 4-Wire Connections diagram	27
Figure 17. Front Panel with Basics sample display	29
Figure 18. Basic Σ RMS sample display	30
Figure 19. Harmonics Bargraph and List sample display	31
Figure 20. Waveforms V&W CONT ϕ ABC sample display	32
Figure 21. History WATTS ϕ A sample display	33
Figure 22. Basics Σ RMS MEAS ϕ A display with callouts	36
Figure 23. Basics Σ RMS MEAS $\Sigma\phi$ ABC display	36

Figure 24. Basics Σ RMS INRUSH ϕ A display	36
Figure 25. Basics Σ RMS INRUSH $\Sigma\phi$ ABC display	37
Figure 26. Basics Σ RMS INTEGRATED ϕ A display with callouts	37
Figure 27. Basics Σ RMS INTEGRATED $\Sigma\phi$ ABC display	37
Figure 28. Basics Σ RMS INTEGR AVG ϕ A display	37
Figure 29. Basics Σ RMS INTEG AVG $\Sigma\phi$ ABC display	38
Figure 30. Basics DC MEAS ϕ A display	38
Figure 31. Basics DC MEAS $\Sigma\phi$ ABC display	38
Figure 32. Basics DC INRUSH ϕ A display	38
Figure 33. Basics DC INRUSH $\Sigma\phi$ ABC display	39
Figure 34. Basics DC INTEGRATED ϕ A display	39
Figure 35. Basics DC INTEGRATED $\Sigma\phi$ ABC display	39
Figure 36. Basics DC INTEG AVG ϕ A display	39
Figure 37. Basics DC INTEG AVG $\Sigma\phi$ ABC display	39
Figure 38. Basics FUND ϕ A display with callouts	40
Figure 39. Basics FUND $\Sigma\phi$ ABC display	40
Figure 40. Basics Σ HARMS ϕ A display with callouts	40
Figure 41. Basics Σ HARMS $\Sigma\phi$ ABC display	41
Figure 42. Harmonics Bargraph ϕ A, VOLTS % Log display	41
Figure 43. Harmonics ϕ A VOLTS ABS Lin display	41
Figure 44. Harmonics Bargraph ϕ A, VOLTS ABS Log display	42
Figure 45. Harmonics Bargraph ϕ A, VOLTS % Lin display	42
Figure 46. Harmonics Bargraph ϕ A, AMPS % Log display	42
Figure 47. Harmonics Bargraph ϕ A, AMPS ABS Lin display	42
Figure 48. Harmonics Bargraph ϕ A, AMPS ABS Log display	42
Figure 49. Harmonics Bargraph ϕ A, AMPS % Lin display	43
Figure 50. Harmonics List ϕ A, ABSOLUTE display	43
Figure 51. Harmonics List ϕ A, PERCENTAGE display	43
Figure 52. Harmonics List ϕ A, PHASE display	44
Figure 53. Harmonics List ϕ B, PHASE display	44

Figure 54. Waveforms V&A CONT ϕ A display with callouts _____	44
Figure 55. Waveforms V&A CONT ϕ B display _____	45
Figure 56. Waveforms V&A CONT ϕ C display _____	45
Figure 57. Waveforms V&A CONT $\Sigma\phi$ ABC display _____	45
Figure 58. Waveforms V&W CONT ϕ A display _____	45
Figure 59. Waveforms V&W CONT $\Sigma\phi$ ABC display _____	45
Figure 60. History VOLTS ϕ A RMS display with callouts _____	46
Figure 61. History VOLTS $\Sigma\phi$ ABC RMS display _____	46
Figure 62. History VOLTS ϕ A PEAK display _____	46
Figure 63. History VOLTS $\Sigma\phi$ ABC PEAK display _____	46
Figure 64. History VOLTS ϕ A THD display _____	47
Figure 65. History VOLTS $\Sigma\phi$ ABC THD display _____	47
Figure 66. History AMPS ϕ A RMS display _____	47
Figure 67. History AMPS $\Sigma\phi$ ABC RMS display _____	47
Figure 68. History AMPS ϕ A PEAK display _____	47
Figure 69. History AMPS $\Sigma\phi$ ABC PEAK display _____	48
Figure 70. History AMPS ϕ A THD display _____	48
Figure 71. History AMPS $\Sigma\phi$ ABC THD display _____	48
Figure 72. History WATTS ϕ A display _____	48
Figure 73. History WATTS $\Sigma\phi$ ABC display _____	48
Figure 74. History VAR ϕ A display _____	49
Figure 75. History VAR $\Sigma\phi$ ABC display _____	49
Figure 76. History PF ϕ A display _____	49
Figure 77. History PF $\Sigma\phi$ ABC display _____	49
Figure 78. Phase A Basic Measurement printout _____	53
Figure 79. Total Basic Measurements printout _____	54
Figure 80. Phase A Current Harmonics Barchart graphic printout _____	55
Figure 81. Phase A Current Harmonics Barchart nongraphic printout _____	56
Figure 82. Phase B Harmonics Data List printout _____	57
Figure 83. Phase A Waveforms graphic printout _____	58

Figure 84. Phase A Volts and Current Waveforms nongraphic printout _____	59
Figure 85. Phase B Waveforms graphic printout _____	60
Figure 86. Waveforms Volts, Amps, Power graphic printout _____	61
Figure 87. Phase A Current Level History graphic printout _____	62
Figure 88. Phase A Current Level History nongraphic printout _____	63
Figure 89. Setup Index screen with Current Inputs selected _____	65
Figure 90. Input Selection selected _____	66
Figure 91. Calibration selected _____	66
Figure 92. DC Zero Date selected _____	66
Figure 93. Calibration selected _____	68
Figure 94. Calibration Date selected _____	68
Figure 95. Open Circuit Point _____	68
Figure 96. Open Circuit Point Zero Readings _____	69
Figure 97. Voltage Point initial display _____	69
Figure 98. Internal Voltage Point display _____	70
Figure 99. External Voltage Point Phase A _____	70
Figure 100. External Voltage Point Phase B _____	71
Figure 101. External Voltage Point Phase C _____	71
Figure 102. Internal Current Cal Point display _____	72
Figure 103. Load "A" Current Cal Point display _____	72
Figure 104. Load "B" Current Cal Point display _____	73
Figure 105. Load "C" Current Cal Point display _____	73
Figure 106. Internal Current Calibration Completion display _____	74
Figure 107. External Transducer A Current Cal Point display _____	74
Figure 108. External Transducer B Current Cal Point display _____	74
Figure 109. External Transducer C Current Cal Point display _____	75

Introduction

The purpose of this user guide is to describe the use and capabilities of the 2553 and 2553E (External Current) Three-Phase Power Analyser.

Scope

The three-phase 2553 is an easy-to-use, general purpose power analyser, which may be configured for 1 ϕ 2-wire, 1 ϕ 3-wire, 3 ϕ 3-wire or 3 ϕ 4-wire power sources and loads. Overall, the 2553 analyzes the electrical power delivered to or by a device. The unit can be quickly set up on your bench top. You can adjust the viewing angle using the handle and adjust the contrast from the configuration screen.

The 2553 Option E provides support for external current transducers of the current:current or current:voltage type. This option also provides terminals at the rear panel allowing the user to power external circuitry from the 2553's internal DC power supplies (positive and negative 15V).

Both the 2553 and 2553E analysers display voltage, current and wattage "results" in numeric and graphic waveform formats. Results include voltage, current, wattage and harmonic frequencies in absolute, percentage and phase. You may display the fundamental in a bargraph format through the 40th harmonic or in a listing format through the 50th harmonic. You may examine power waveforms graphically and chart historical results in divisions of time from seconds to days. Additional screens display voltage and current peaks, harmonics, averages and reactive power with K-factor and crest factor of the voltage or current signal.

All of the data that can be displayed on the 2553/2553E screens can be printed in full-page printout formats. Refer to *Printing Results* page 51. Note that both bargraph and listing fundamental printouts contain the 2nd through the 50th harmonics.

Features

The 2553/2553E Power Analysers' features include the following—

- Simple interface.
- Display basic measurements of ? RMS, DC, Fundamental (harmonic), and ?Harmonics for any single phase or the total of all phases.
- Display harmonics in bargraph or a list format.
- Continuously updated displays of voltage, current and wattage waveforms.
- Display historic results for voltage and current, watts, reactive power and power factor, for each of the three phases and the total, simultaneously.
- Allowance for scaling of all current readings by a numerical factor.
- Provide adjustable display contrast.

Functional Description

This chapter describes the circuitry and interfaces of the 2553/2553E.

Theory of Operation

The 2553/2553E is high performance test equipment. Within the analyser, voltage and current signals are converted to digital data using DSP chips where the signals are sampled automatically and periodically. A to D converters scale and sample data. The data-analysis components analyze voltage and current input samples for harmonic content.

The following is a list of the significant components and a description of their function within the analyser.

Voltage Attenuators—Resistively attenuate the voltages present on the SOURCE A, B, C and N terminals to a 2.5V peak-amplitude maximum voltage signal.

Hall Effect Transducer—Converts the current flowing from each phase SOURCE to LOAD into isolated voltages of the 2553.

Analog Anti-Alias Filters—Reduce the bandwidth of the signals applied to the inputs of the ADCs to less than the sampling frequency.

Each of the attenuator outputs and the outputs of the Hall Effect transducers are passed through identical analog anti-alias filters.

16-Bit A to D converters (ADC) and First In/First Out memory (FIFO)—

The ADCs digitize each signal with 16-bit resolution at the DSP generated Sample Clock frequency. The FIFOs store each digital sample in memory to be read by the DSP in blocks of 32 samples per converter.

80 MIPS Digital Signal Processor (DSP)—Processes the tasks required to compute the multiple voltage, current, and power results. Also processes the tasks required to format the results for display, printout and interrogation via the IEEE488 interface. Computed results are independent of the selected display and IEEE488 interface requirements.

The DSP generates a Sample-Clock signal from the computed frequency of the user-selected synchronization source. The Sample-Clock signal clocks the ADCs at a suitable frequency to ensure exact synchronization of the overall measurements to the applied signals. The sampling frequency may be up to 170KHz and is slightly "dithered" to ensure that individual samples cannot be at the exact same phase of the applied signals, while maintaining exact synchronization for the overall measurement period.

The samples read from the FIFOs are passed through one to three stages of 6-pole elliptical filters. (The stage of filtering is dependent on user-selected configuration and bandwidth of harmonics measurements.) The first stage filters the samples for all nonharmonic measurements. The second stage is anti-alias filtering of the samples for the DFT and waveform collection. The third stage filters the samples for waveform period measurements to display the synchronized results.

All measurements are made nominally over four cycles of the applied signal and then two-pole filtered with a user-selected "averaging" filter to produce fast, yet stable, measurement results. (Note that there are more cycles at very high frequencies and less at very low frequencies.)

Historical results are maintained by the DSP from the unfiltered measurement results. Harmonics results, both amplitude and phase, are computed by the DSP by means of a variable length Discrete Fourier Transform (DFT). Nominally 400 equally spaced samples per cycle are also collected for waveform display purposes.

At nominal line frequencies and below, all measurements are continuous, there being no missed portions of the signal in any of the resultant measurements. At very high frequencies "gaps" can only result in the harmonics measurements.

The DSP also contains 4Kx24 of internal RAM for working memory, 3Kx24 of program memory and a 1Kx24 level 1 cache memory.

The DSP can perform one arithmetic and two data movements per 12.5ns, yielding 80MIPs for arithmetic operations and 240MIPs overall capability.

IEEE488 Interface—Performs the majority of the bus interface details for the IEEE488 protocol. All IEEE-448 interfacing is with data output from the DSP, or data and commands input to the DSP. This interface is controlled using a commercially available IC (National Instruments TNT488).

Parallel Printer Interface—This IC performs the majority of the bus interface details for the parallel printer protocol. The data to be output over the interface comes from the DSP. This interface is controlled using a commercially available IC.

Graphical Display Module—Allows a visual reading of the results in alphanumeric and/or graphical format. The display screen is a commercially available LCD with 240x64 pixels and a CCD backlight. All graphical information for the screens is generated by the DSP.

Keyboard—Allows for changing and bringing up the various displays of results. The keyboard is formed by six key switches, each individually readable by the DSP. All actions taken as a result of a key being pressed are generated by the DSP.

Real Time Clock (RTC) and Non-Volatile Memory (NVRAM)—Generates the date and time of day information, and also stores the user display configuration, the IEEE488 address, and the calibration data for each input. Both clock and memory are within a single commercially available IC.

Random Access Memory (RAM)—A total of 256Kx24, 15ns access time memory is available to the DSP to store all "working" information, all computed results, formatted printout data and display pixels. This memory also contains the software program for the DSP, copied from the Flash Memory.

Flash Program Memory—This memory is rewritable "Flash" memory used for DSP program storage. The program is copied into RAM following application of power and is CRC checked for integrity. After being copied into RAM, the flash memory is not used during normal operation.

Interfaces

Note: *Specifications are subject to change without notice.*

Front Panel

Liquid Crystal Display—

240 x 64 High-Speed Graphics LCD with CCD Backlight (5" x 1.35" viewing area)

Keyboard—

Two fixed purpose keys + four softkeys

Parallel Printer

Printer Interface—

Parallel IEEE1284

Format—

Unformatted text or PCL (user selectable)

Data Rate—

Up to 1000 characters per second (limited by printer)

Compatible Printers—

Text: any 80 character wide (or more) by 66 character long (or more) ASCII parallel text printer

PCL: Hewlett-Packard DeskJet family, Hewlett-Packard LaserJet family, other PCL level two (or higher) compatible parallel printer with 75dpi or greater raster graphics print resolution

IEEE488

Interface—

IEEE488.1 (Certain commands conform to IEEE488.2)

Addressing—

Single address, user selectable via front panel between 0 and 29 inclusive

Capabilities—

SH1 AH1 T6 L4 SR1 RL1 PP0 DC1 DT1 C0 E2 (350ns min. T1)

Max. Talk Data Rate—

>200,000 bytes per second

Max. Listen Data Rate—

>50,000 bytes per second

Command Set—

All front panel capabilities are provided via ASCII textual command sequences.

Results—

Any results may be obtained at any time from the interface as ASCII textual numerical data. Additionally, status and state interrogatives are provided for "on the fly" determination of product status.

Using the Power Analyser

The purpose of this chapter is to describe how to set up and use the 2553/2553E. This chapter covers—

- Setting Up
- Using the Front Panel Buttons
- Rear Panel Connections
- Power Testing

Setting Up

The Power Analyser is made to sit on your bench. You can optimize the viewing angle by adjusting the handle and optimize the viewing brightness by adjusting the DISPLAY CONTRAST. (See *Configuring the Power Analyser* page 20.)



Figure 1. Bench Type Power Analyser

◆ **To adjust the handle—**

1. Press and hold the buttons located where the handle attaches to the case sides.
2. Rotate the handle until it clicks into place.



WARNING: IF THE POWER ANALYSER IS USED IN A MANNER NOT SPECIFIED BY Vitrek, THE PROTECTION PROVIDED BY THE EQUIPMENT MAY BE IMPAIRED.

Front Panel

The front panel on the 2553 and 2553E includes a LCD display screen, power switch and buttons. The buttons are from left to right: NEXT, F1, F2, F3, F4 and PRINT. See below.

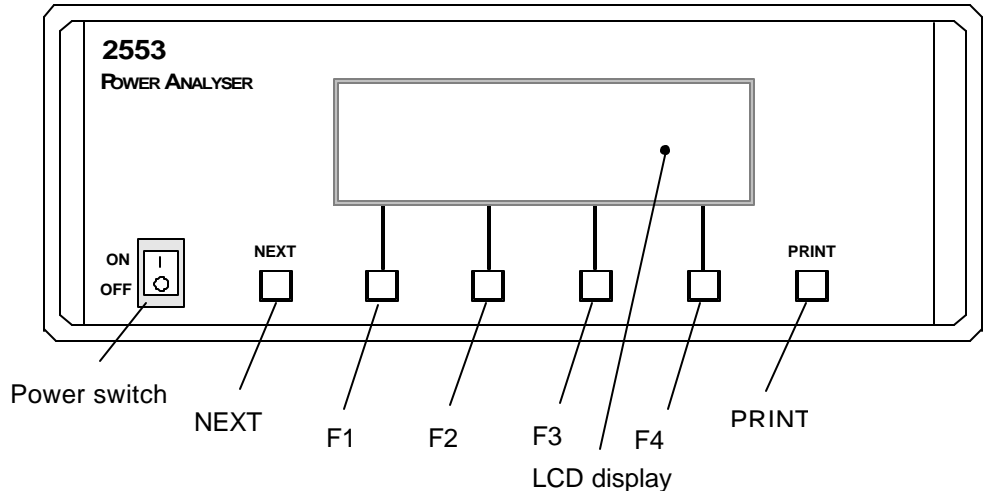

Figure 2. Front Panel detail

The screen shows the power measurement results numerically and graphically. Refer to *Viewing Results*, page 35.

The ON/OFF button powers the 2553/2553E on or off.

The NEXT button allows you to toggle through the five main display groups. Refer to *Sequence of Display Screens*, page 29.

The F1 through F4 buttons (functional softkeys) allow you to select menu choices. For more information refer to *Viewing Results*, page 35.

The PRINT button allows you to print a full page of data reflecting the display results. Printouts are formatted either graphically or tabulated. (Refer to *Printing Results* page 51.)

Rear Panel Connections



The 2553 and 2553E rear panels provide connectors for a power cord, parallel printer cable and computer interface cable. The 2553E additionally provides three external current (bnc) connectors and three transducer voltage plugs. See below.

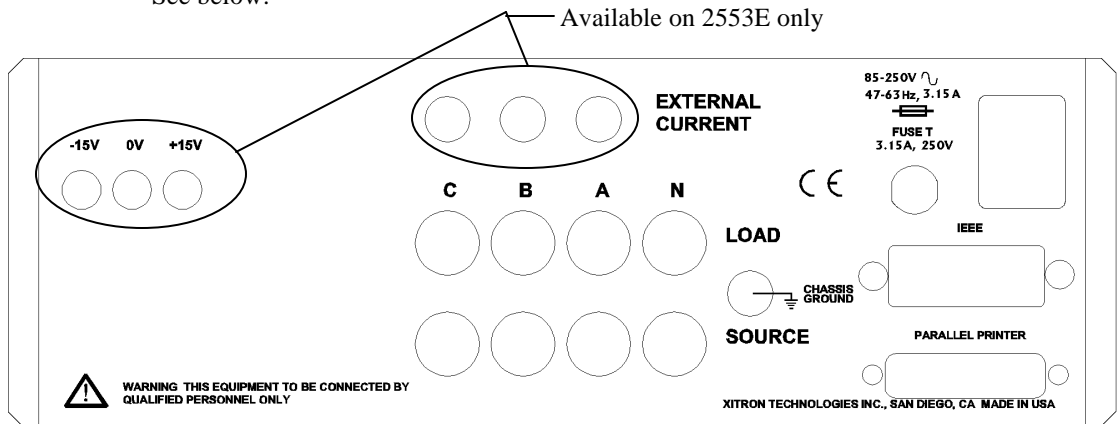

Figure 3. Rear Panel detail

◆ To power the 2553/2553E—

- Insert the socket end of the power cord into the rear panel's 3-prong connector. Insert the plug end into an 85-250 volt AC, 47 - 63 Hz outlet.



WARNING: SHOCK HAZARD. LETHAL VOLTAGES OR CURRENT MAY BE PRESENT. ENSURE NO VOLTAGE OR CURRENT EXISTS ON THESE CONNECTIONS PRIOR TO ATTEMPTING TO CONNECT TO THESE INPUT TERMINALS.

◆ To connect a printer to the 2553/2553E—

- For printer interface, connect one end of your printer's cable to the PARALLEL PRINTER port and the other to the printer.

◆ To connect a PC to the 2553/2553E—

1. Attach the computer's IEEE488 cable connector to the 24-pin socket marked IEEE on the rear panel.
2. On the front panel, press the NEXT button until you see the **Setup Index** display.
3. Press CURSOR until INTERFACES/DATE/TIME is highlighted.
4. Press the SETUP button. The screen changes to show the Interface Setup Index display.
5. Press CURSOR until the IEEE ADDRESS option is selected.
6. Press the CHANGE button until the appropriate address number displays.
7. Press DONE.

Starting the Power Analyser

- ◆ *To start the 2553/2553E, click the ON/OFF button to the ON position.*

A startup screen will display for a few seconds. This screen lists the model number, current and voltage input options, software revision number, and firmware installation date and time.

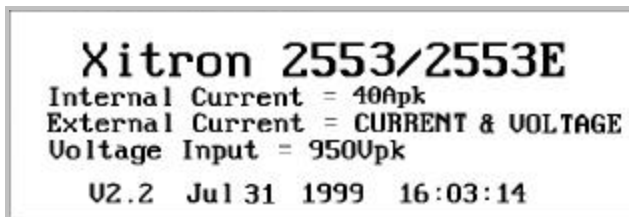

Figure 4. Startup screen

Note: If your unit is not calibrated, a *WARNING* statement will display along the top of the Startup screen stating either: “*UNCALIBRATED INSTRUMENT*” or “*CALIBRATION DATA HAS BEEN LOST.*”

The next display you will see is the same screen that displayed when the analyser was last turned off.

Configuring the Power Analyser

The **Setup Index** screen gives you access to separate interface configuration screens. There is a screen for Interfaces/Date/Time; Measurements; Current Input (selection and scaling); Calibration and one to view Product Options. Refer to *Figure 5*, *Figure 7*, *Figure 9*, and *Figure 11*.

- ◆ *To reconfigure the power analyser —*
 1. Press the NEXT button until you see the main **Setup Index** screen display, as shown below.



Figure 5. Setup Index screen with INTERFACES/DATE/TIME selected

2. Press the CURSOR button to highlight the configuration item of choice and press SETUP. The screen will change to display the selected item's configuration screen.

◆ **To setup the Printer, IEEE488 address interface, date and time—**

1. With INTERFACES/DATE/TIME highlighted, press the SETUP button. The display changes to the **Interface Setup** display.

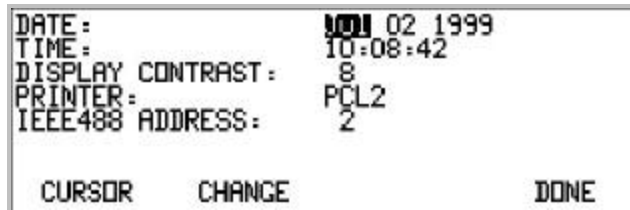

Figure 6. The Interface Setup screen

2. Use the CURSOR key to highlight any portion of the display that you desire to modify. Press the CHANGE key to change the highlighted portion to the next available option for that data.
 - DATE = month, day, year.
 - TIME = (24) hours = minutes = seconds.
 - DISPLAY CONTRAST = 0 to 15 (default is 8)
 - PRINTER = PCL2; None; Text. Note that selecting *None* for the printer type disables the PRINT button in all screens.
 - IEEE488 ADREESS = 1 through 29

Note: If you pass an option you desire, you can come back to it by continuing to press CURSOR.

3. Press the DONE key to save any changes made, and to return to the **Setup Index** screen.

◆ **To configure the measurements —**

1. From the main **Setup Index** display, press the CURSOR button to highlight MEASUREMENTS & WIRING.



Figure 7. Setup Index screen with MEASUREMENTS & WIRING selected

- Press the SETUP button. The display changes to the **Measurements & Wiring Setup** display.



Figure 8. The Measurements & Wiring Setup screen

- Use the CURSOR key to highlight any portion of the display that you desire to modify. Press the CHANGE key to change the highlighted portion of the display to the next available option for that data.

WIRING = 1φ 2-wire(AN); 1φ 3-wire(ANB); 3φ 3-wire (ABC); **3φ 4-wire (ABCN)**

FREQUENCY RANGE = .02Hz- 20Hz; 20Hz- 75KHz; **20Hz- 5KHz**; 2Hz- 2KHz; 0.2Hz- 200Hz

INPUT COUPLING = **AC & DC**; AC only

AVG RESULTS = 50ms; **250ms**; 1s; 2.5s; 5s; 10s; 20s; 1min

SYNC SOURCE = **Voltage**; Current; 50Hz; 60Hz; 400Hz; No Harmonics

- Press the DONE key to save any changes made, and to return to the main **Setup Index** screen.

◆ *To configure the Current Input*

Note that the Current Input configuration screen includes selection and scaling. The current scale allows you to scale all current readings by a numerical factor. Separate scale factors are stored for each current input option, and are entered as transducer input:output ratio. Each scale factor may also be negative, effectively reversing the polarity of current flow for that phase.

- From the **Setup Index** display, press the CURSOR button twice. The CURRENT INPUTS choice is now highlighted as shown below.



Figure 9. Setup Index screen with CURRENT INPUTS selected

2. Press the SETUP button. The display changes to the **Current Input Setup** display. See example shown below.



Figure 10. The Current Input Setup screen

3. Use the CURSOR key to highlight any portion of the display that you desire to modify. Press the CHANGE key to change the highlighted portion of the display to the next available option for that data.

INPUT SELECTION = External (Volts); Internal: External (Amps)

The scaling limits for current are within:

SCALING (IN=OUT) = +0000 .00A = 00.0000A to -9999 .99A = 99.9999A

The scaling limits for voltage are within:

SCALING (IN=OUT) = +0000 .00V = 00.0000V to -9999 .99V = 99.9999V

4. Press the DONE key to save any changes made, and to return to the **Setup Index** screen. Note that the scale factor for each available current input is stored separately.

Note: To remove DC offset and calibrate the power analyser, refer to the Calibration section on page 65.

◆ *To view the Option Content of your Power Analyser*

1. From the **Setup Index** display, press the CURSOR button four times. The PRODUCT OPTIONS FITTED choice is now highlighted as shown below.



Figure 11. Setup Index screen with *PRODUCT OPTIONS FITTED* selected

2. Press the SETUP button. The display will show the **Product Options Fitted** screen. See an example shown below.



Figure 12. The Product Options Fitted screen

3. Press the DONE key to return to the **Setup Index** screen.

Measurement Connections



WARNING: IF THE POWER ANALYSER IS USED IN A MANNER NOT SPECIFIED BY VITREK, THE PROTECTION PROVIDED BY THE EQUIPMENT MAY BE IMPAIRED.

CAUTION: FOR ALL CONNECTIONS, KEEP INPUT AND OUTPUT WIRING SEPARATED.

Using Internal Current Transducers

When using the internal current transducer of the power analyser, access the **Current Input Setup** screen. Set the INPUT SELECTION to *Internal* and *+1.0:1.0* for Scaling. Refer to the connections shown below.

Internal Transducer Connections for Test



Turn the source power off for the device-under-test before making any connection. Attach the test device to the input terminals on the analyser's rear panel.

Note: Ensure that 2553/2553E is configured for the same wiring technique that you are using for the connection.

Refer to the following connection diagrams for each wiring configuration—

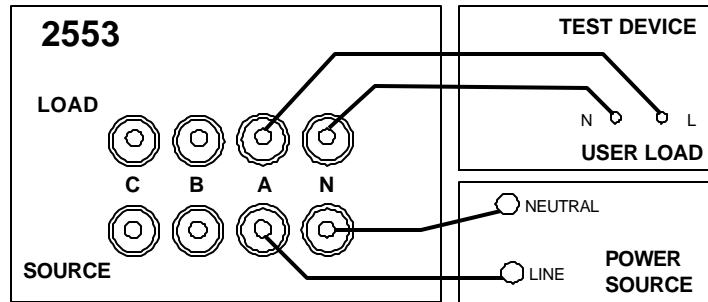

Figure 13. 1 f 2-Wire Connections diagram

WARNING: SHOCK HAZARD. LETHAL VOLTAGES OR CURRENT MAY BE PRESENT. ENSURE NO VOLTAGE OR CURRENT EXISTS ON THESE CONNECTIONS PRIOR TO ATTEMPTING TO CONNECT TO THESE INPUT TERMINALS.

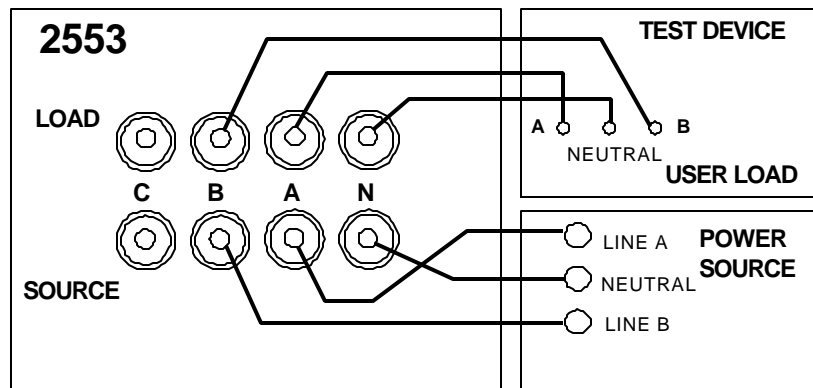

Figure 14. 1 f 3-Wire Connections diagram

Note: Phasing of A and B is unimportant.

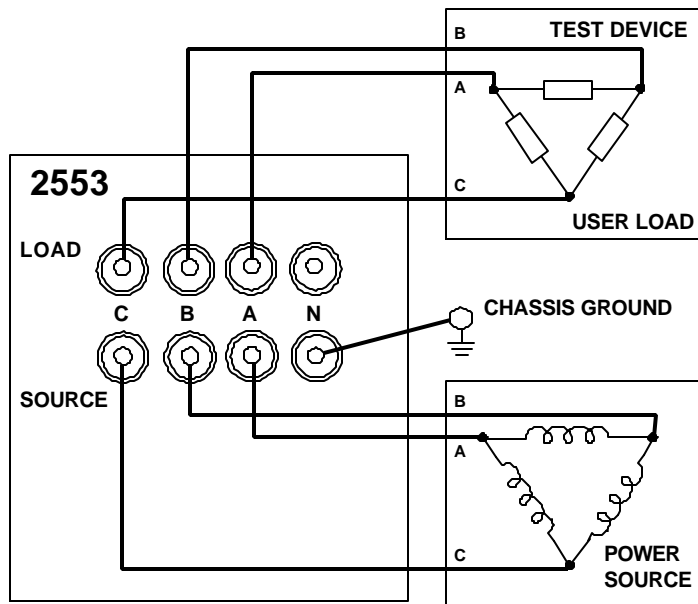

Figure 15. 3 f 3-Wire Connections diagram

WARNING: SHOCK HAZARD. LETHAL VOLTAGES OR CURRENT MAY BE PRESENT. ENSURE NO VOLTAGE OR CURRENT EXISTS ON THESE CONNECTIONS PRIOR TO ATTEMPTING TO CONNECT TO THESE INPUT TERMINALS.

Notes:

1. Phasing of A, B and C is unimportant.
2. This wiring configuration may also be used when the 2553/2553E has been set for 3 f 4-wire. In that case the 2553/2553E will display the phase to ground voltages, however, the VA and VAR values may not be valid.

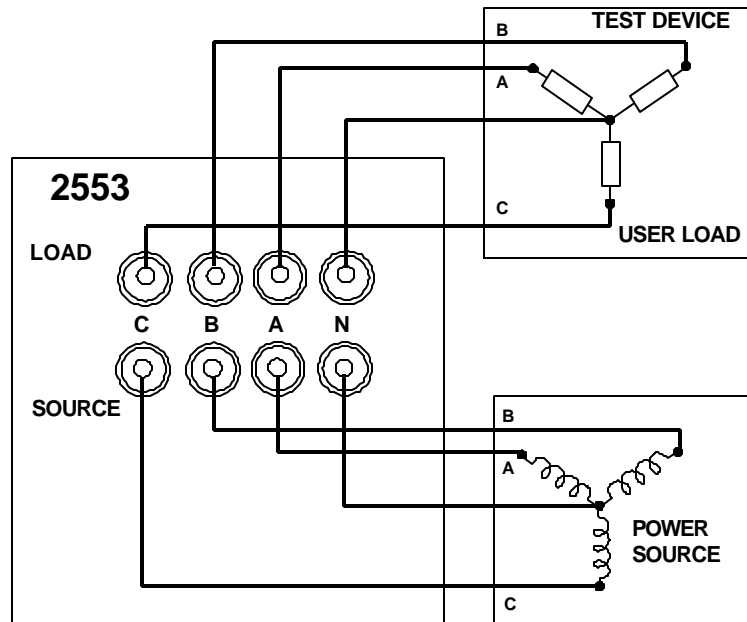

Figure 16. 3φ 4-Wire Connections diagram

WARNING: SHOCK HAZARD. LETHAL VOLTAGES OR CURRENT MAY BE PRESENT. ENSURE NO VOLTAGE OR CURRENT EXISTS ON THESE CONNECTIONS PRIOR TO ATTEMPTING TO CONNECT TO THESE INPUT TERMINALS.

Notes:

1. Phasing of A, B and C is unimportant.
2. If either the Power Source or User Load does not have a neutral connector, then that wire may be omitted.
3. This wiring configuration may also be used when the 2553/2553E has been set for 3φ 3-wire. In that case the 2553/2553E will display the phase to phase voltages.

Using External Current Transducers

When using the external current transducer, access the **Current Input Setup** screen. Set the correct type of current transducer (*External Amps* or *Volts*) for INPUT SELECTION and +1.0 for Scaling.

External Transducer Connections for Test

Connections are similar to those shown in the internal current transducers, however, only the SOURCE, Phase and Neutral connections need be directly made to the 2553. Pass each phase current conductor to the load through an external current transducer. Connect the output of the transducer to the respective BNC terminal on the 2553 rear panel.

Note the following -

- Each of the “Live” phase connections should be passed through current transducers. Thus 1 transducer is required for 1-phase 2-wire (phase A), 2 for 1-phase 3-wire (phase A and B), and 3 for 3-phase 3-wire or 4-wire configurations.
- Take special care that the same phase is connected to each respective SOURCE terminal as that for which the current transducer output is connected to the respective BNC terminal.
- If the power analyser unexpectedly displays negative watts indications, this is an indication that the current flow in the transducer is reversed. Either the wire is reversed in the transducer, or the transducer output has the incorrect polarity. This may be resolved by correcting the wiring or by setting the current input scale factor in the power analyser to a negative polarity.
- If a transducer is being used, which does not have DC current capability, then *AC Only* input coupling should be chosen in the **Measurements Setup** screen.
- If a transducer is being used, which has DC current capability, and the user desires to measure any DC current content, then *AC & DC* input coupling should be chosen in the **Measurements Setup** screen of the power analyser. The user should perform the DC offset correction procedure as described on page 65, after making the connections and allowing the external transducer to settle after application of its power.
- Particularly when operating at low current levels, it may be important to ensure that the voltage signals cannot capacitively couple into the current transducer outputs. The use of flexible coaxial cable is recommended for the current transducer output wiring.

Sequence of Display Screens

This chapter shows the sequence of the display screens in a diagram format.

Using the Diagrams

The NEXT button takes you through the five main groups of display screens: **Setup**, **Basics**, **Harmonics**, **Waveforms** and **History**. The group names are assigned here to assist in navigating and do not display on the screen. **Setup Index** is used for configuring the analyser and is described in *Using the Power Analyser, page 17*. The other four displays are used to view results and are introduced in the following sequence diagrams. Within each main group there are various display screens that are accessible using the softkey buttons.

Refer to *Figure 17* below—

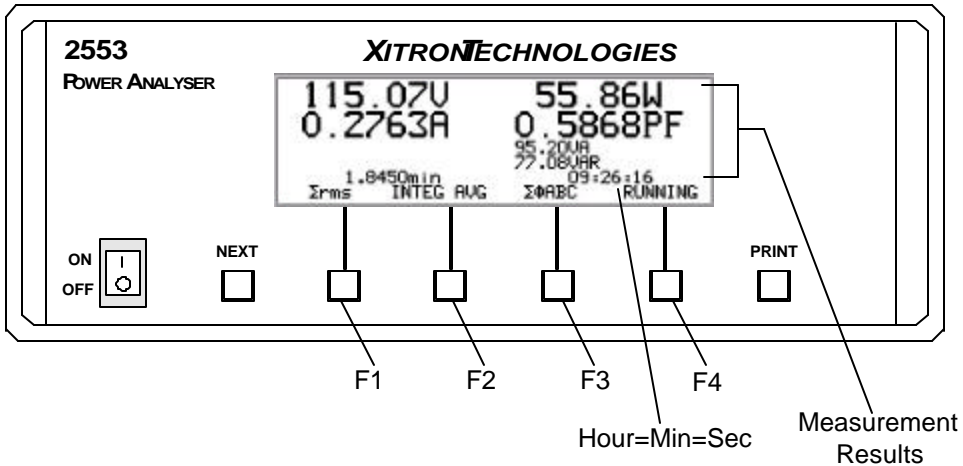
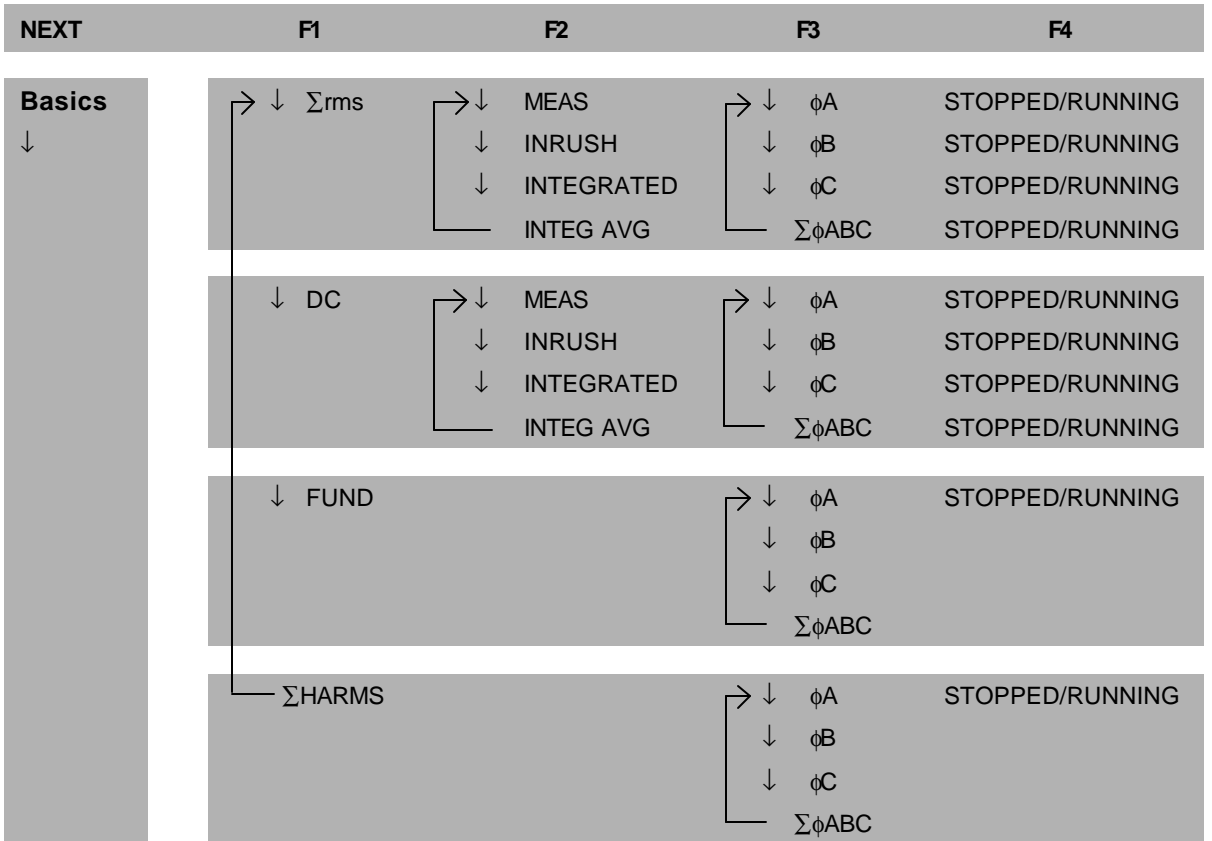

Figure 17. Front Panel with Basics sample display

Diagrams



Note: If you wish to display $\hat{a}HARMS$, and $FUND$, press the button in the F2 position (second softkey from left) until MEAS comes up, then press F1 (first softkey on left).

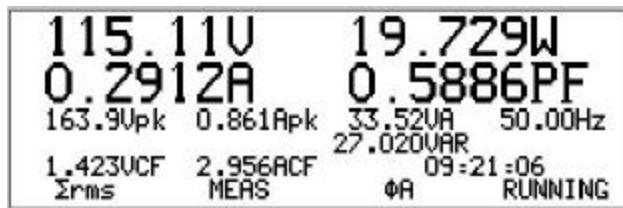
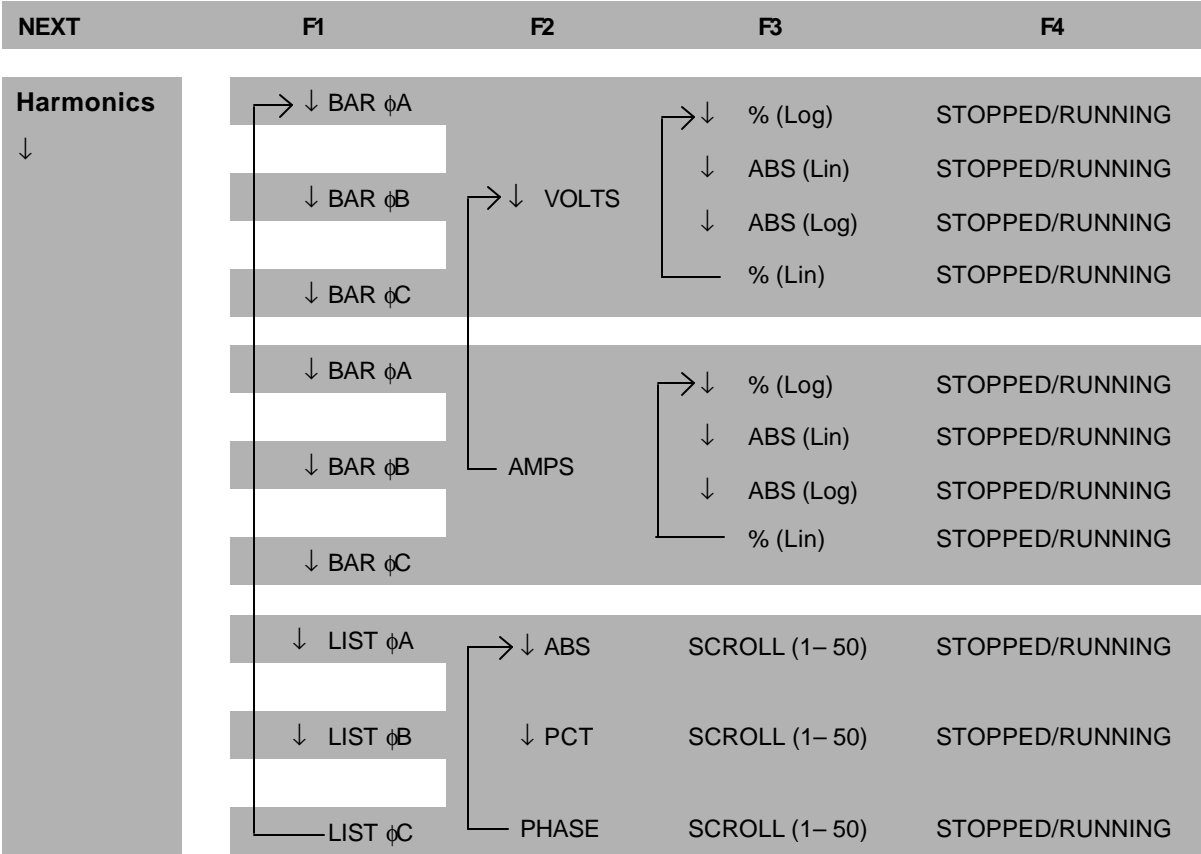

Figure 18. Basic $\hat{a}RMS$ sample display



Note: Some or all of the three phases, φA, φB, and φC, may be present depending on the wiring configuration.

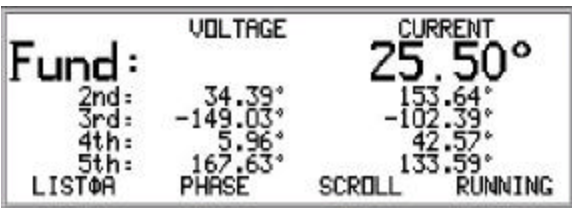
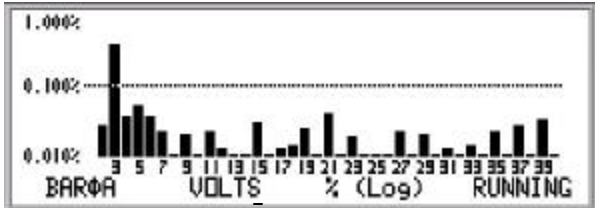

Figure 19. Harmonics Bargraph and List sample display

NEXT	F1	F2	F3	F4
Waveforms ↓	V&A CONT	↓ ZOOM x 0.5	↓ ϕA	STOPPED/RUNNING
		↓ ZOOM x 1	↓ ϕB	STOPPED/RUNNING
		↓ ZOOM x 2	↓ ϕC	STOPPED/RUNNING
		ZOOM x 5	ϕABC	STOPPED/RUNNING
	V&W CONT	↓ ZOOM x 0.5	↓ ϕA	STOPPED/RUNNING
		↓ ZOOM x 1	↓ ϕB	STOPPED/RUNNING
		↓ ZOOM x 2	↓ ϕC	STOPPED/RUNNING
		ZOOM x 5	ϕABC	STOPPED/RUNNING

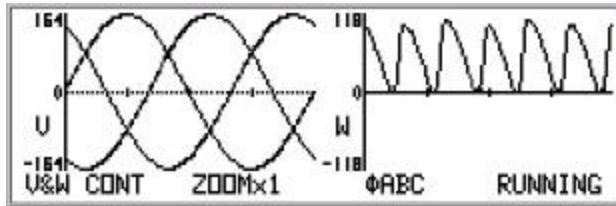

Figure 20. Waveforms V&W CONT fABC sample display

NEXT	F1	F2	F3	F4
History ↓	→ ↓ VOLTS	→ ϕ Arms	→ ↓ 0.4 sec/div	STOPPED/RUNNING
		↓ ϕ Brms	↓ 1 sec/div	STOPPED/RUNNING
		↓ ϕ Crms	↓ 2 sec/div	STOPPED/RUNNING
		↓ Σ ABCrms	↓ 5 sec/div	STOPPED/RUNNING
		↓ ϕ Apk	↓ 10 sec/div	STOPPED/RUNNING
		↓ ϕ Bpk	↓ 30 sec/div	STOPPED/RUNNING
	↓ AMPS	↓ ϕ Cpk	↓ 1 min/div	STOPPED/RUNNING
		↓ Σ ABCpk	↓ 3 min/div	STOPPED/RUNNING
		↓ ϕ Athd	↓ 10 min/div	STOPPED/RUNNING
		↓ ϕ Bthd	↓ 30 min/div	STOPPED/RUNNING
		↓ ϕ Cthd	↓ 1 hr/div	STOPPED/RUNNING
		↓ Σ ABCthd	↓ 3 hr/div	STOPPED/RUNNING
	↓ WATTS	↓ ϕ A	↓ 6 hr/div	STOPPED/RUNNING
	↓ VAR	↓ ϕ B	↓ 12 hr/div	STOPPED/RUNNING
	PF	↓ ϕ C	1 day/div	STOPPED/RUNNING
	Σ ABC			

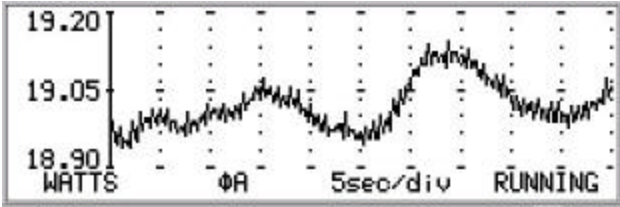

Figure 21. History WATTS ϕ A sample display

Notes:

1. The time scale may be set while displaying any data.
2. Some or all of the three phases (ϕ A, ϕ B, and ϕ C) may be present depending on the wiring configuration.

Viewing Results

Review this chapter to determine which display shows the results that best suit your test requirements.

Display Screens

The screen displays shown here reflect the default options in the **Measurement & Wiring Setup** screen. Refer to *Configuring the Power Analyser*, page 20. For reference those defaults are—

- 20Hz—5KHz, AC & DC
- 3 ϕ 4-wire
- 250ms
- Voltage

The default for DISPLAY CONTRAST is 8.

If AC ONLY has been selected, then Σ_{rms} will read: RMS (AC) and the message: NOT CONFIGURED FOR DC MEASUREMENT will display in the **Basics** DC screen.

If an input signal does not fit inside the configured range (**Measurement & Wiring Setup**), then your analyser may exhibit one of the following conditions—

- The screen may display a limited number of results
- A message may display on the screen instead of results
- You may not have access to the display screens

Throughout this chapter on Viewing Results, the sample display screens shown are most often from phase A results. Note that phase B and C results (if configured) are similar to phase A. Note also that Σ_{AB} or Σ_{ABC} provides the total for all configured phases.

The data is as follows—

- Harmonics, RMS and DC, Volts and Amps: Mean phase value.
- Inrush and Peak, Volts and Amps: Highest phase value.
- Watts, VAR: True vector total of all phases.
- VA: From total watts and VAR.
- Waveforms: All waveforms are shown in the same graph.
- Frequency is always from phase A.

Basics Group

The **Basics** group shows you a complete picture of the power results of your device. It has 40 different total displays screens with up to 14 characteristics included in the screens.

àRMS

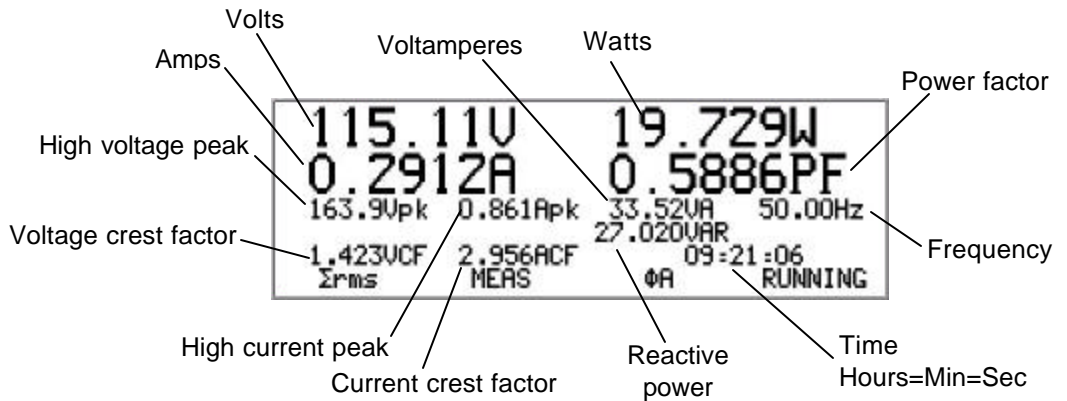

Figure 22. Basics àRMS MEAS fA display with callouts

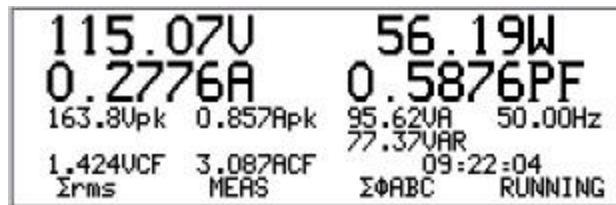

Figure 23. Basics àRMS MEAS àfABC display

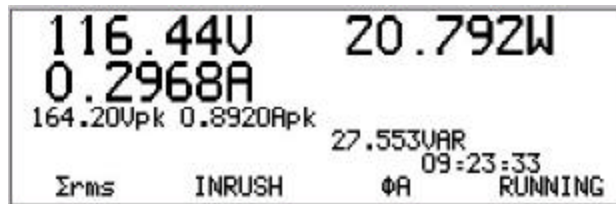

Figure 24. Basics àRMS INRUSH fA display

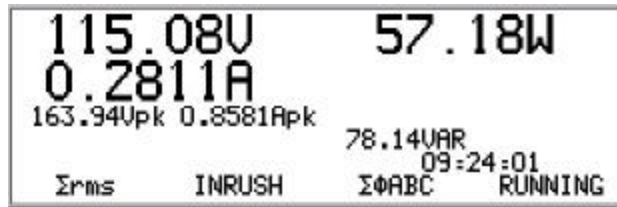

Figure 25. Basics àRMS INRUSH àfABC display

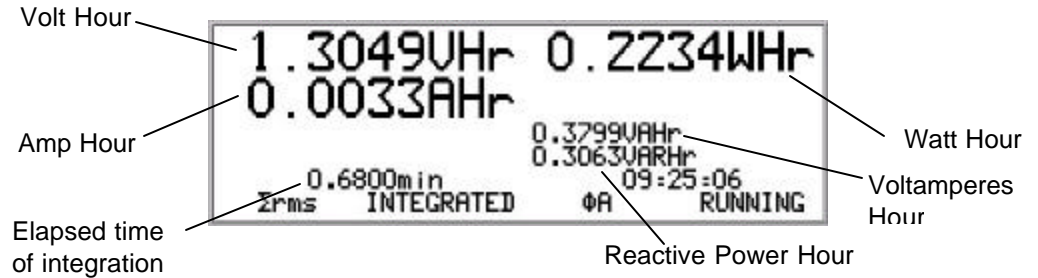

Figure 26. Basics àRMS INTEGRATED fA display with callouts



Figure 27. Basics àRMS INTEGRATED àfABC display

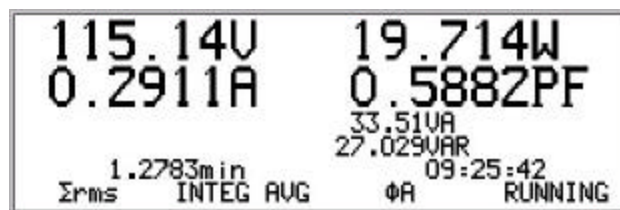

Figure 28. Basics àRMS INTEGR AVG fA display

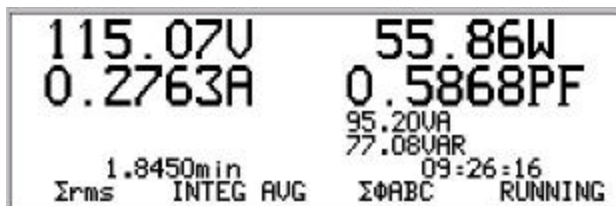

Figure 29. Basics \hat{a} RMS INTEG AVG \hat{a} fABC display

DC



Figure 30. Basics DC MEAS f_A display



Figure 31. Basics DC MEAS \hat{a} fABC display

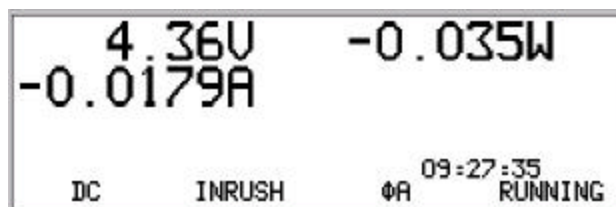

Figure 32. Basics DC INRUSH f_A display



Figure 33. Basics DC INRUSH àfABC display



Figure 34. Basics DC INTEGRATED fA display



Figure 35. Basics DC INTEGRATED àfABC display

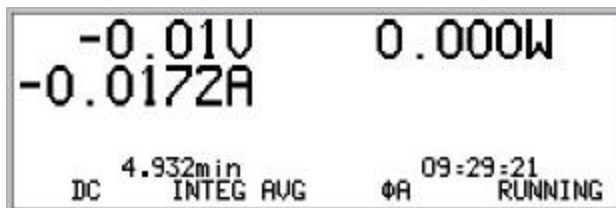

Figure 36. Basics DC INTEG AVG fA display



Figure 37. Basics DC INTEG AVG àfABC display

FUND

If you wish to view the FUND displays, you must press the button in the F2 position until MEAS comes up, then press F1.

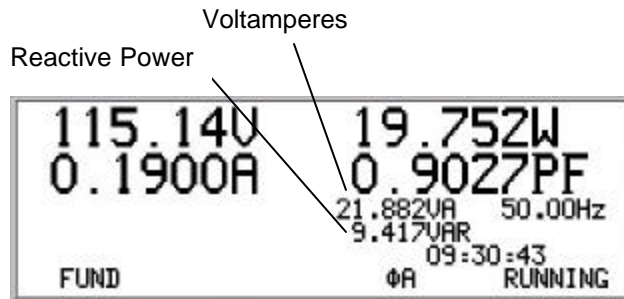

Figure 38. Basics FUND f_A display with callouts

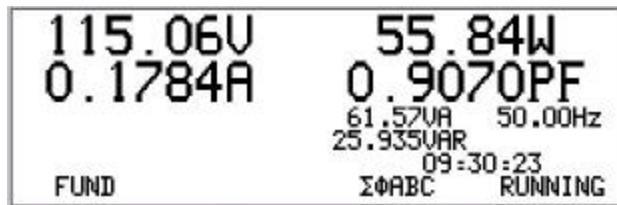

Figure 39. Basics FUND a_{ABC} display

aHARM

If you wish to view the Σ HARM display, you must press the button in the F2 position until MEAS comes up, then press F1.

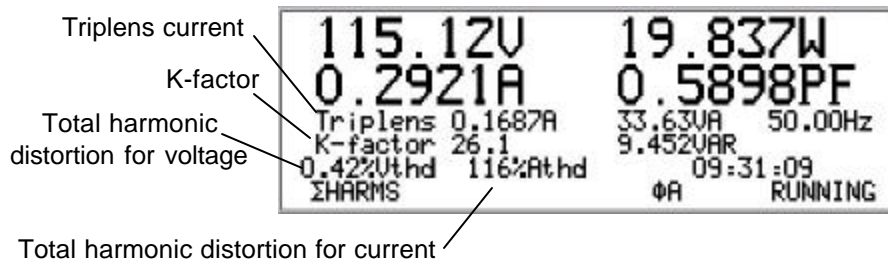

Figure 40. Basics a_{HARMS} f_A display with callouts

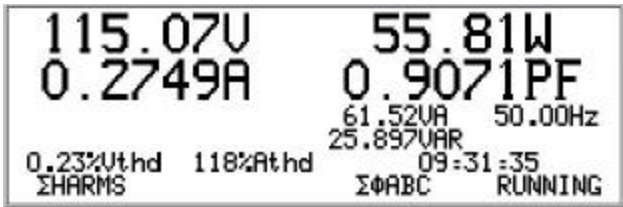

Figure 41. Basics Σ HARMS Σ fABC display

Harmonics Group

The **Harmonics** group of screens show harmonic results. These results can be viewed in a list or bargraph format. The List format shows the fundamental harmonic through to the 50th harmonic. The bargraph format shows through to the 40th harmonic.

Bargraphs

The bargraph displays show the fundamental through the 40th harmonic for current and voltage in—

- Linear or logarithmically scaled percentage units
- Linear or logarithmically scaled absolute units

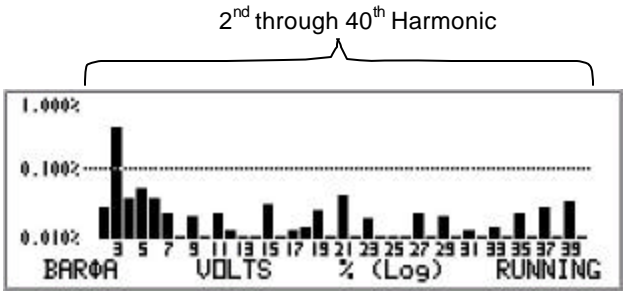

Figure 42. Harmonics Bargraph Φ A, VOLTS % Log display

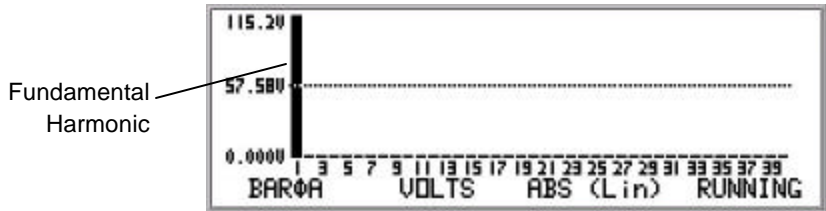

Figure 43. Harmonics Φ A VOLTS ABS Lin display

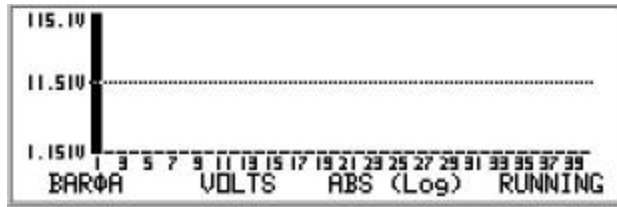

Figure 44. Harmonics Bargraph \bar{f}_A , VOLTS ABS Log display

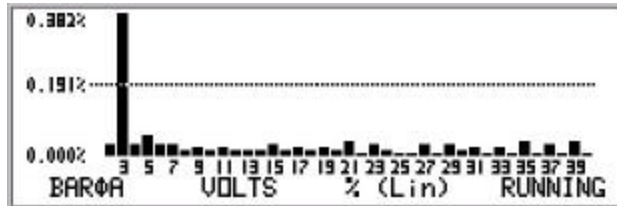

Figure 45. Harmonics Bargraph \bar{f}_A , VOLTS % Lin display

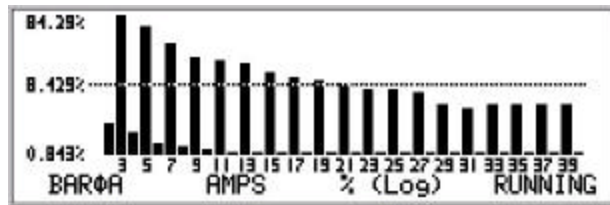

Figure 46. Harmonics Bargraph \bar{f}_A , AMPS % Log display

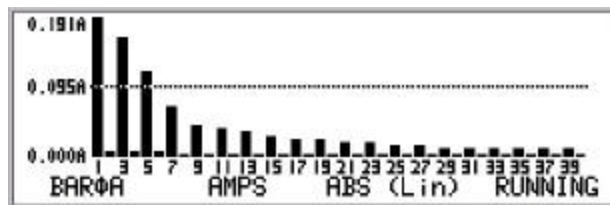

Figure 47. Harmonics Bargraph \bar{f}_A , AMPS ABS Lin display

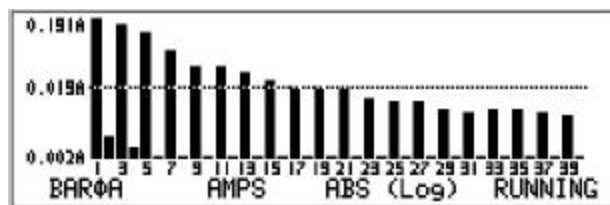

Figure 48. Harmonics Bargraph \bar{f}_A , AMPS ABS Log display

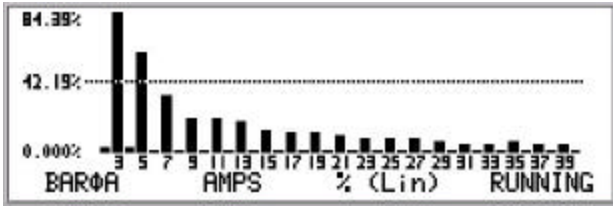

Figure 49. Harmonics Bargraph fA, AMPS % Lin display

Lists

Each LIST display screen is limited to a few lines. Use the Scroll button to view the fundamental through the 50th harmonic result.

The List screens show harmonics in—

- Absolute with THD
- Percentages with THD
- Phase (shift to phase A voltage fundamental)

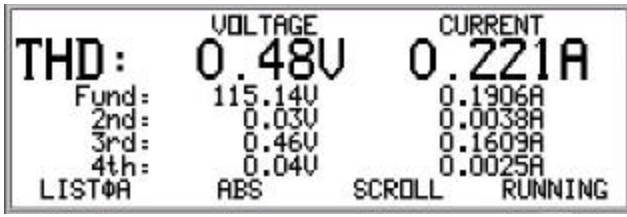

Figure 50. Harmonics List fA, ABSOLUTE display

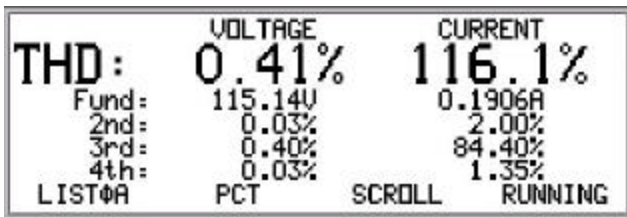

Figure 51. Harmonics List fA, PERCENTAGE display

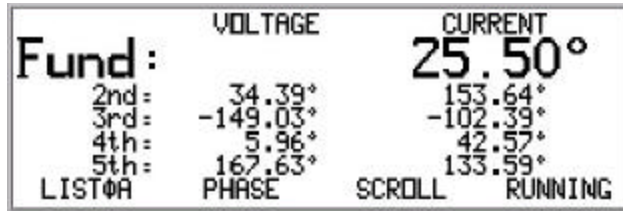

Figure 52. Harmonics List fA, PHASE display

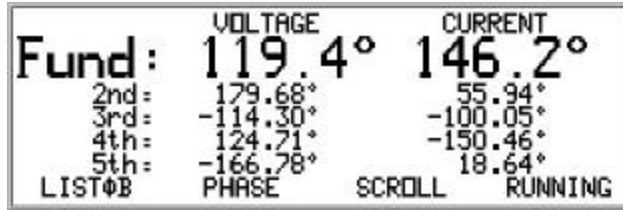

Figure 53. Harmonics List fB, PHASE display

Waveforms Group

The **Waveforms** group shows continuous results for voltage, current and wattage. The display screens are in xy waveform format.

Each screen displays two waveforms for comparison purposes with additional information provided with an inset.

The waveforms can be viewed at zoom levels of x0.5, x1, and x5. The analyser will automatically center the input results vertically on the screen, no matter what the range.

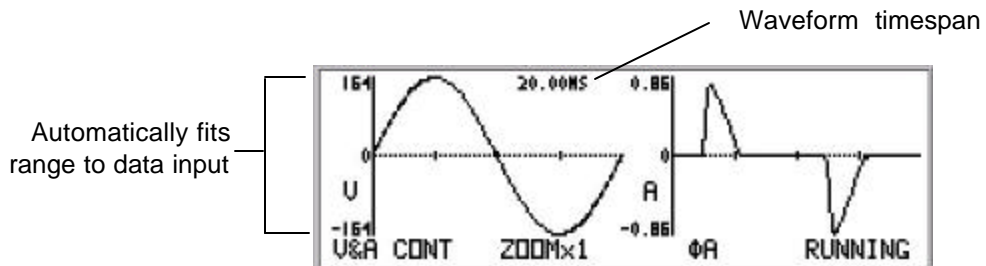

Figure 54. Waveforms V&A CONT fA display with callouts

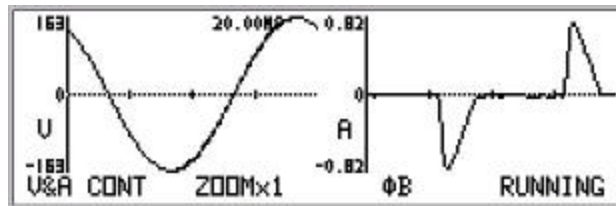

Figure 55. Waveforms V&A CONT f_B display

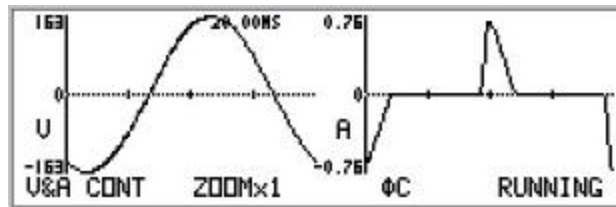

Figure 56. Waveforms V&A CONT f_C display

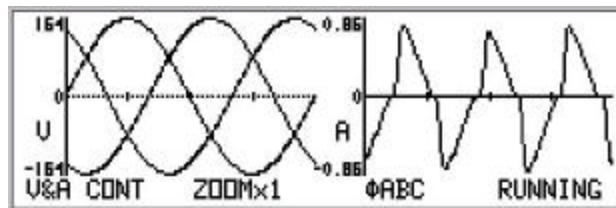

Figure 57. Waveforms V&A CONT f_{ABC} display

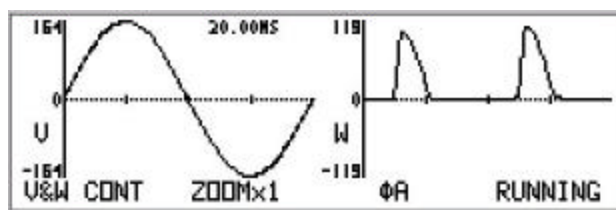

Figure 58. Waveforms V&W CONT f_A display

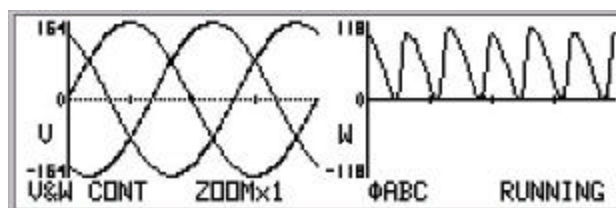

Figure 59. Waveforms V&W CONT f_{ABC} display

History Group

The **History** group gives you accumulated results at the following rates: 0.4 second, 1 second, 2 seconds, 5 seconds, 10 seconds, 30 seconds, 1 minute, 3 minutes, 10 minutes, 30 minutes, 1 hour, 3 hours, 6 hours, 12 hours, and one day per division.

The analyser will automatically scale and center the input results vertically on the screen.

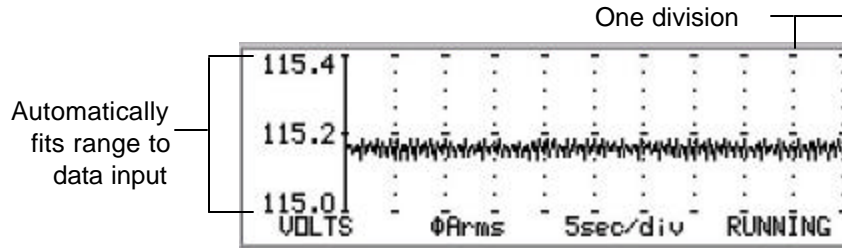

Figure 60. History VOLTS f_A RMS display with callouts

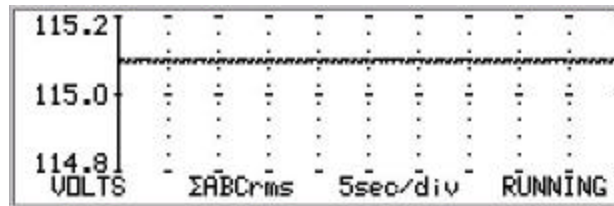

Figure 61. History VOLTS $\hat{a}fABC$ RMS display

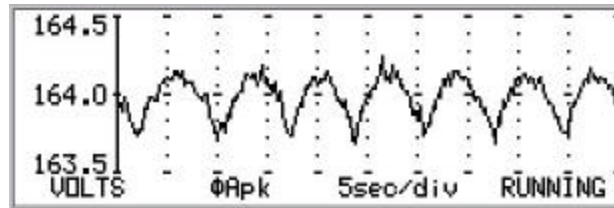

Figure 62. History VOLTS f_A PEAK display

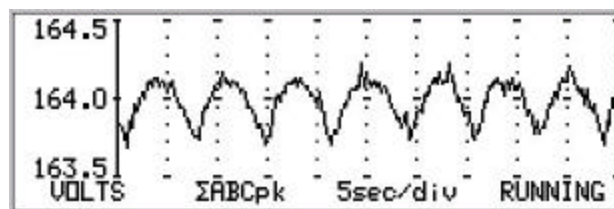

Figure 63. History VOLTS $\hat{a}fABC$ PEAK display

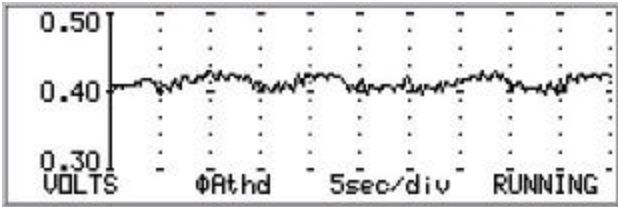

Figure 64. History VOLTS fA THD display

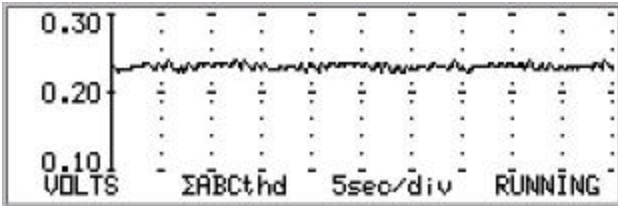

Figure 65. History VOLTS fABC THD display

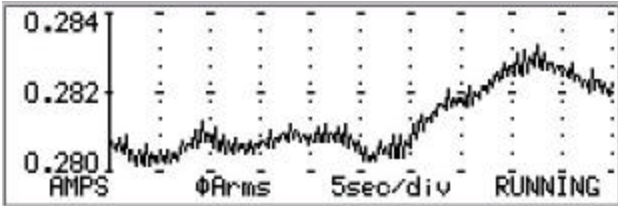

Figure 66. History AMPS fA RMS display

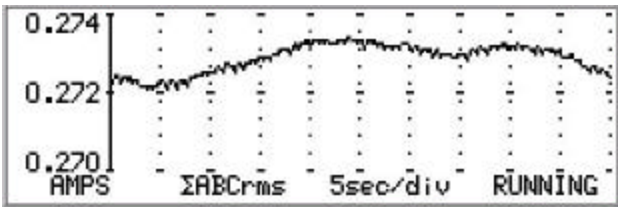

Figure 67. History AMPS fABC RMS display

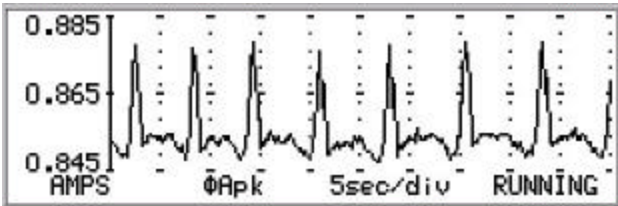

Figure 68. History AMPS fA PEAK display

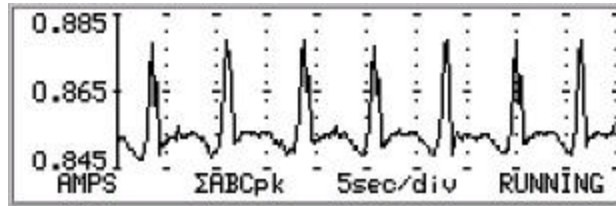

Figure 69. History AMPS à fABC PEAK display

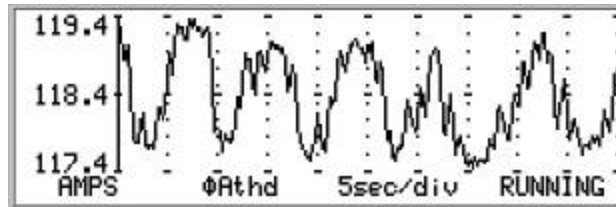

Figure 70. History AMPS fA THD display

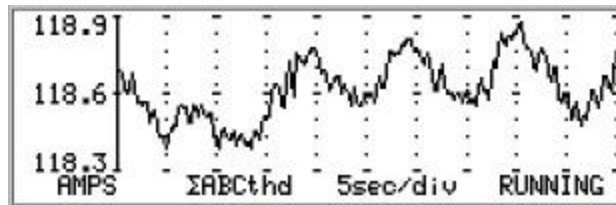

Figure 71. History AMPS à fABC THD display

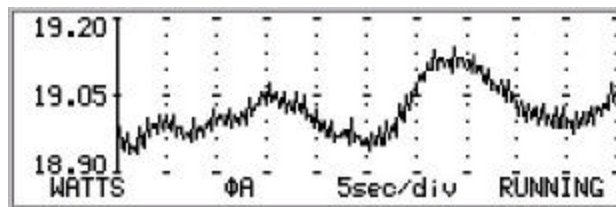

Figure 72. History WATTS fA display

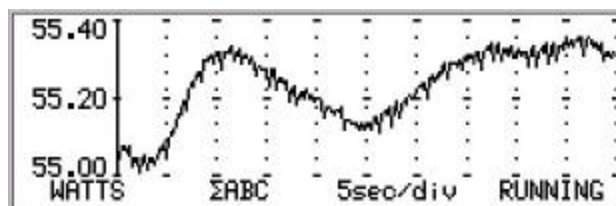

Figure 73. History WATTS à fABC display

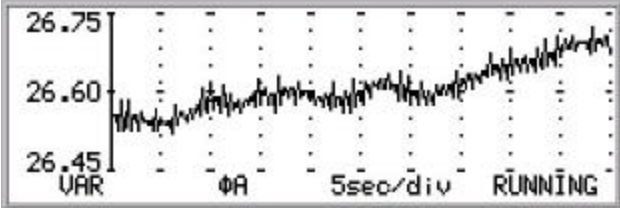

Figure 74. History VAR fA display

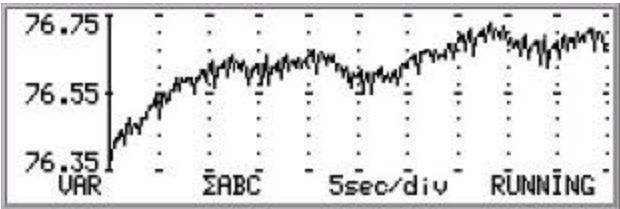

Figure 75. History VAR a fABC display

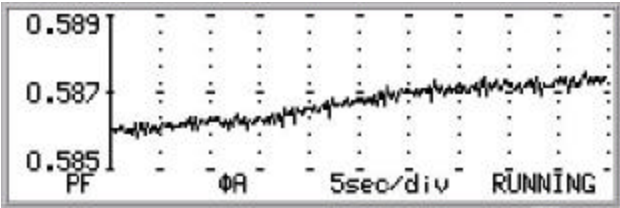

Figure 76. History PF fA display

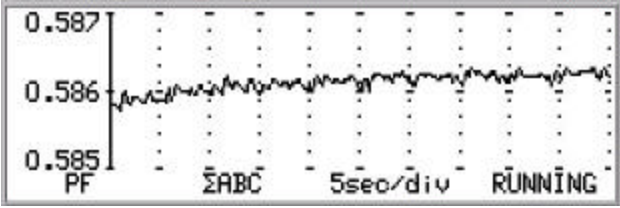

Figure 77. History PF a fABC display

Printing Results

This chapter illustrates some of the various printouts available using the 2553/2553E. Each printout reflects the data from the display group you are presently viewing.

Sample Printouts

To get the type of printout you want, check your setting in the **Interface Setup** screen. A text or graphic print is immediately initiated when the PRINT key is pressed for each of the results display screens.

Every printout includes—

- Descriptive title of the data
- Configuration selections
- Current date in month, day, year
- Calibrated date
- Time in hours : minutes : seconds
- Elapsed time
- Vitrek 2553 or Vitrek 2553E
- Version number

Note: *Select PCL2 within the **Interface Setup** screen for graphical printouts.*

The samples provided have been printed from each of the display groups **Basics**, **Harmonics**, **Waveforms**, and **History**. In each case, the specific phase or sum of phases prints out in accordance with the phase presently displaying.

- From the **Basics** group, you can print all the data for any one phase or the sum of all phases (total) on one page. See *Figure 78* and *Figure 79*.
- From the **Harmonics** Bargraph group you can print separate bargraphs for absolute or percent, linear or logarithmically, and current or voltage. See *Figure 80* and *Figure 81*.
- From the **Harmonics** List group, you can print absolute, percentage, or phase data on one page. See *Figure 82*.

- From the **Waveforms** group, you can print volts, amps and power waveforms all on one page, if a graphic printer is selected. See *Figure 83*, *Figure 85*, and *Figure 86*. If a text-only printer is selected, then volts and amps will print in a textual representation of the waveforms. See *Figure 84*.
- Each **History** display will print a full page of formatted data. See *Figure 87* and *Figure 88*.

The following pages illustrate some sample printouts.

For a printout like the following, press the PRINT button from any one of the **Basics** display screens. For phase A data press the PRINT button when ϕA is displaying in the F3 position, etc. for phase B and C.

Xitron 2553 v2.1		PHASE A BASIC MEASUREMENTS			
		Sep 21 1999, 09:23:20			
		MEASURED	INRUSH	INTEGRATED TOTAL	FOR 0.0000Hr AVERAGE
FREQUENCY		60.00Hz			
VOLTAGE	RMS :	115.08V	116.05V	0.0000VHr	0.00V
	Fundamental :	115.07V			
	Harmonic :	115.07V			
	DC :	0.01V	-7.10V	0.0000VHr	0.00V
		163.36V	171.26V		
	Crest Factor	1.420			
	THD :	0.12%			
CURRENT	RMS :	0.318A	0.423A	0.0000AHr	0.000A
	Fundamental :	0.318A			
	Harmonic :	0.318A			
	Triplens :	0.002A			
	Odd Triplens :	0.002A			
	DC :	0.011A	0.031A	0.0000AHr	0.000A
		0.480A	2.873A		
	Crest Factor	1.507			
		0.72%			
WATTS	Total :	36.59W	37.98W	0.0000WHr	0.00W
	Fundamental :	36.59W			
	Harmonic :	36.51W			
	DC :	0.00W	0.22W	0.0000WHr	0.00W
VAR	Total :	0.68VAR	14.73VAR	0.0000VARHr	0.00VAR
	Fundamental :	0.11VAR			
	Harmonic :	0.02VAR			
VA	Total :	36.63VA		0.0000VAHr	0.00VA
	Fundamental :	36.59VA			
	Harmonic :	36.59VA			
	DC :	0.00VA	0.22VA	0.0000VAHr	0.00VA
POWER FACTOR	Total :	0.9992			0.0000
	Fundamental :	0.9999			
	Harmonic :	0.9978			
LOAD	K-Factor	1.00			
Configured for 3-phase, 4-wire					
Bandwidth = 20Hz- 75KHz AC & DC 50 harmonics Sync = Voltage					
Results averaged over 250ms					
Current Input = Internal					
+0001.00A:01.0000A/+0001.00A:01.0000A/+0001.00A:01.0000A					
Calibrated on Sep 21 1999					

Figure 78. Phase A Basic Measurement printout

For a printout of the total **Basics** Measurements, press the PRINT button from any one of the **Basics** displays when ? ABC is showing in the F3 position.

Xitron 2553 v2.1		TOTAL BASIC MEASUREMENTS Sep 21 1999, 08:10:10			
		MEASURED	INRUSH	INTEGRATED TOTAL	FOR 0.0000Hr AVERAGE
FREQUENCY		60.03Hz			
VOLTAGE	RMS :	120.26V	122.03V	0.0000VHr	0.00V
	Fundamental :	120.20V			
	Harmonic :	120.25V			
	DC :	0.02V	3.63V	0.0000VHr	0.00V
	Peak	171.86V	172.66V		
	Crest Factor	1.429			
	THD :	2.84%			
CURRENT	RMS :	0.062A	0.066A	0.0000AHr	0.000A
	Fundamental :	0.030A			
	Harmonic :	0.055A			
	Triplens :	0.032A			
	Odd Triplens :	0.032A			
	DC :	0.005A	0.009A	0.0000AHr	0.000A
	Peak :	0.625A	0.059A		
	Crest Factor :	10.097			
	THD :	156.68%			
WATTS	Total :	10.71W	11.68W	0.0000WHr	0.00W
	Fundamental :	10.65W			
	Harmonic :	10.45W			
	DC :	0.00W	0.03W	0.0000WHr	0.00W
VAR	Total :	-19.32VAR	-30.86VAR	0.0000VARHr	0.00VAR
	Fundamental :	-0.44VAR			
	Harmonic :	-0.37VAR			
VA	Total :	22.16VA		0.0000VAHr	0.00VA
	Fundamental :	10.65VA			
	Harmonic :	10.46VA			
	DC :	0.00VA	0.03VA	0.0000VAHr	0.00VA
POWER FACTOR	Total	0.4952			0.0000
	Fundamental	0.9995			
	Harmonic	0.9995			
LOAD	K-Factor :	27.83			
Configured for 3-phase, 4-wire					
Bandwidth = 20Hz- 75KHz AC & DC 50 harmonics Sync = Voltage					
Results averaged over 250ms					
Current Input = Internal					
+0001.00A:01.0000A/+0001.00A:01.0000A/+0001.00A:01.0000A					
Calibrated on Sep 21 1999					

Figure 79. Total Basic Measurements printout

Press the PRINT button from **Harmonics BAR** ϕ A AMPS % (Log) screen to print a barchart like the one shown below. Each **Harmonics** display screen will print separately. Configure the analyser for a PCL2 printer.

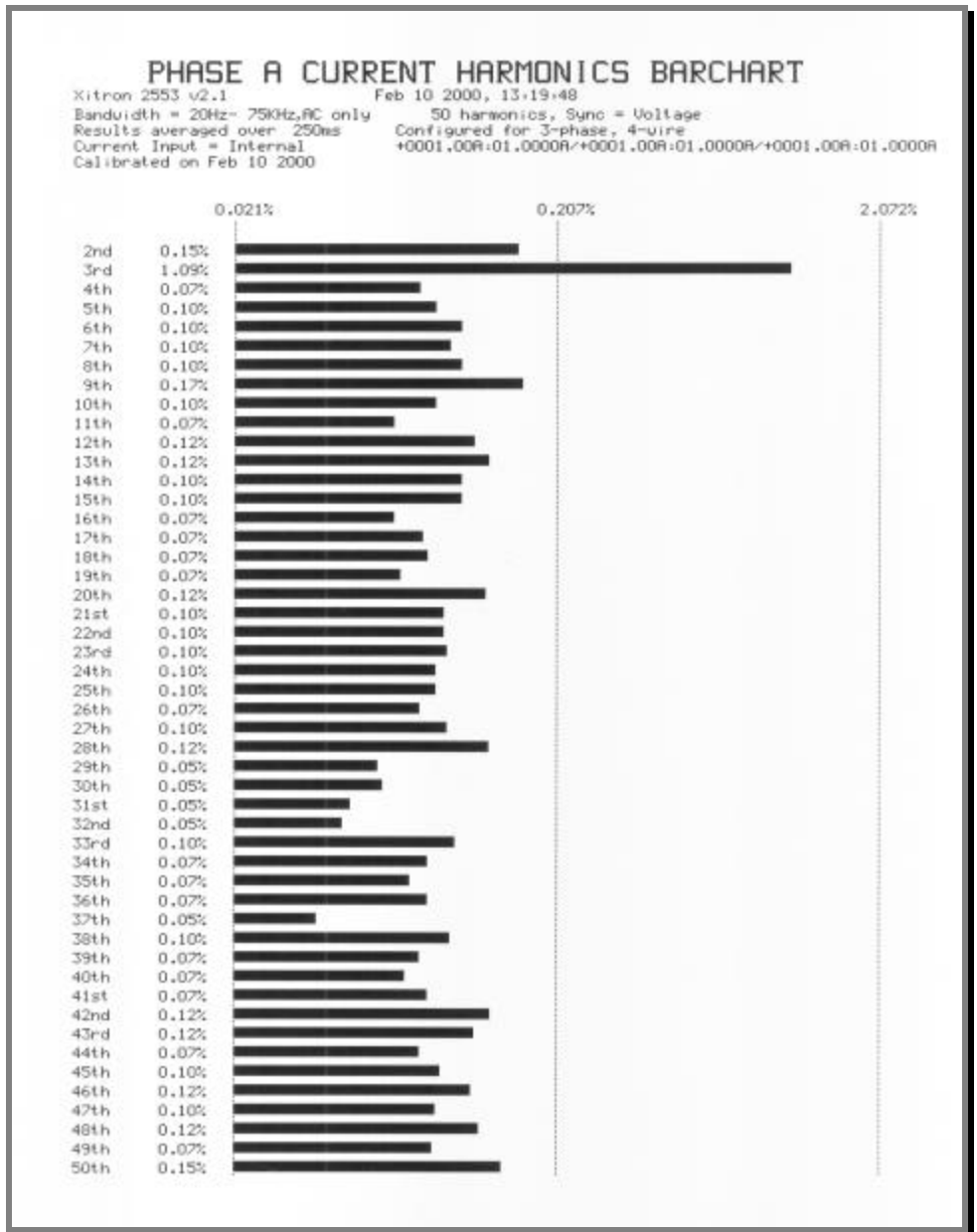

Figure 80. Phase A Current Harmonics Barchart graphic printout

Press the PRINT button from **Harmonics** BAR ϕ A AMPS % (Log) screen to print a barchart like the one shown below. Each **Harmonics** display screen will print separately. This sample printed with the analyser configured for Text printer.

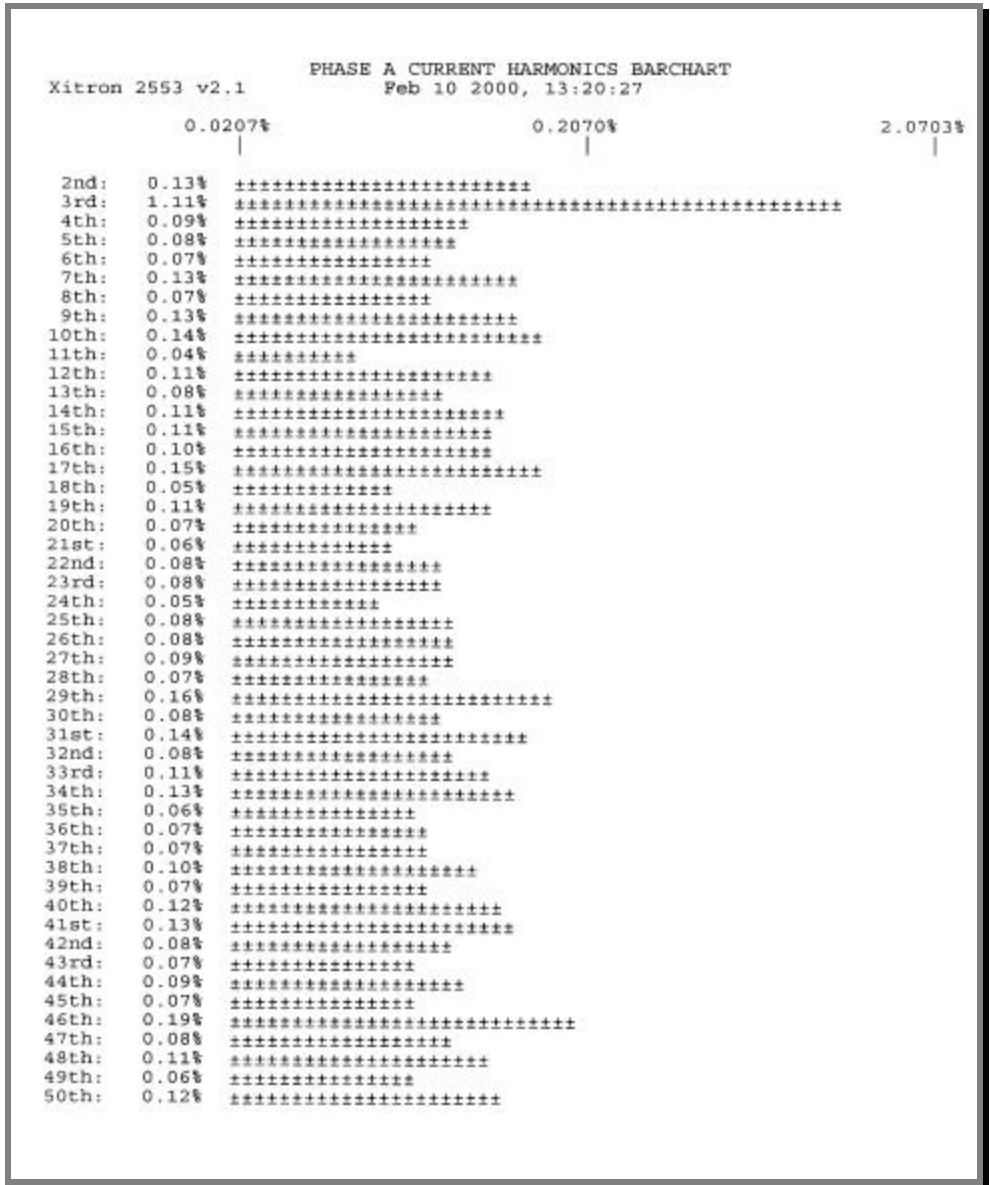

Figure 81. Phase A Current Harmonics Barchart nongraphic printout

Press the PRINT button from any **Harmonics** List display screen to print out PCT, ABS and PHASE data for both voltage and current. Each **Harmonics** List printout includes the fundamental through all available harmonics up to the 50th.

Xitron 2553 v2.1		PHASE B HARMONICS DATA LIST				
		Sep 21 1999, 09:21:15				
		VOLTAGE		CURRENT		
THD :	0.11V			0.002A	0.69%	
Fund:	115.09V	0.10%	120.16deg	0.323A		120.39deg
2nd:	0.05V	0.04%	-45.04deg	0.001A	0.17%	-176.49deg
3rd:	0.01V	0.00%	-66.57deg	0.002A	0.63%	-84.14deg
4th:	0.04V	0.04%	32.80deg	0.000A	0.05%	21.03deg
5th:	0.03V	0.02%	168.38deg	0.000A	0.06%	45.19deg
6th:	0.03V	0.03%	-102.79deg	0.000A	0.03%	93.68deg
7th:	0.02V	0.02%	-50.42deg	0.000A	0.03%	-15.57deg
8th:	0.01V	0.01%	-84.33deg	0.000A	0.03%	-159.57deg
9th:	0.02V	0.02%	80.59deg	0.000A	0.03%	111.56deg
10th:	0.00V	0.00%	-143.30deg	0.000A	0.02%	-44.29deg
11th:	0.02V	0.02%	175.86deg	0.000A	0.03%	92.68deg
12th:	0.00V	0.00%	13.99deg	0.000A	0.03%	-20.38deg
13th:	0.02V	0.02%	-36.34deg	0.000A	0.03%	9.02deg
14th:	0.00V	0.00%	9.32deg	0.000A	0.03%	140.43deg
15th:	0.02V	0.02%	39.88deg	0.000A	0.03%	99.13deg
16th:	0.01V	0.01%	-158.19deg	0.000A	0.05%	-143.25deg
17th:	0.01V	0.01%	-55.68deg	0.000A	0.03%	2.84deg
18th:	0.01V	0.00%	179.23deg	0.000A	0.03%	-10.16deg
19th:	0.02V	0.02%	8.93deg	0.000A	0.03%	78.57deg
20th:	0.00V	0.00%	-133.11deg	0.000A	0.03%	-65.30deg
21st:	0.01V	0.01%	80.81deg	0.000A	0.08%	170.67deg
22nd:	0.01V	0.01%	8.87deg	0.000A	0.05%	-126.89deg
23rd:	0.03V	0.03%	-125.70deg	0.000A	0.05%	-138.20deg
24th:	0.01V	0.00%	-121.28deg	0.000A	0.05%	-107.35deg
25th:	0.01V	0.01%	91.11deg	0.000A	0.05%	-120.92deg
26th:	0.01V	0.01%	173.48deg	0.000A	0.05%	166.56deg
27th:	0.02V	0.02%	123.43deg	0.000A	0.03%	148.82deg
28th:	0.01V	0.01%	-36.91deg	0.000A	0.02%	-117.65deg
29th:	0.01V	0.01%	20.15deg	0.000A	0.02%	85.50deg
30th:	0.01V	0.00%	-88.26deg	0.000A	0.05%	123.25deg
31st:	0.02V	0.02%	91.11deg	0.000A	0.03%	16.53deg
32nd:	0.01V	0.00%	-73.44deg	0.000A	0.03%	158.52deg
33rd:	0.01V	0.01%	71.05deg	0.000A	0.05%	153.57deg
34th:	0.00V	0.00%	-83.58deg	0.000A	0.05%	22.78deg
35th:	0.02V	0.02%	10.93deg	0.000A	0.05%	-77.72deg
36th:	0.00V	0.00%	-165.12deg	0.000A	0.08%	-73.73deg
37th:	0.01V	0.01%	13.94deg	0.000A	0.05%	46.98deg
38th:	0.00V	0.00%	-67.37deg	0.000A	0.05%	-161.07deg
39th:	0.02V	0.02%	-75.43deg	0.000A	0.03%	-118.13deg
40th:	0.00V	0.00%	-149.07deg	0.000A	0.03%	57.91deg
41st:	0.01V	0.01%	-143.46deg	0.000A	0.03%	-112.46deg
42nd:	0.01V	0.00%	76.77deg	0.000A	0.03%	-157.75deg
43rd:	0.01V	0.00%	-155.96deg	0.000A	0.02%	175.30deg
44th:	0.00V	0.00%	-74.10deg	0.000A	0.02%	-148.61deg
45th:	0.01V	0.01%	-97.71deg	0.000A	0.03%	160.01deg
46th:	0.01V	0.00%	37.43deg	0.000A	0.03%	114.72deg
47th:	0.02V	0.02%	136.13deg	0.000A	0.05%	-127.80deg
48th:	0.01V	0.00%	-16.76deg	0.000A	0.02%	21.60deg
49th:	0.02V	0.02%	126.16deg	0.000A	0.03%	2.82deg
50th:	0.00V	0.00%	142.15deg	0.000A	0.03%	31.20deg

Figure 82. Phase B Harmonics Data List printout

For a similar printout, press the PRINT button from **Waveforms** V&A CONT or V&W CONT screens. For a phase A printout, as shown below, press PRINT when ϕA is displaying in the F3 position, etc for Phase B and C. Configure the analyser for a PCL2 printer.

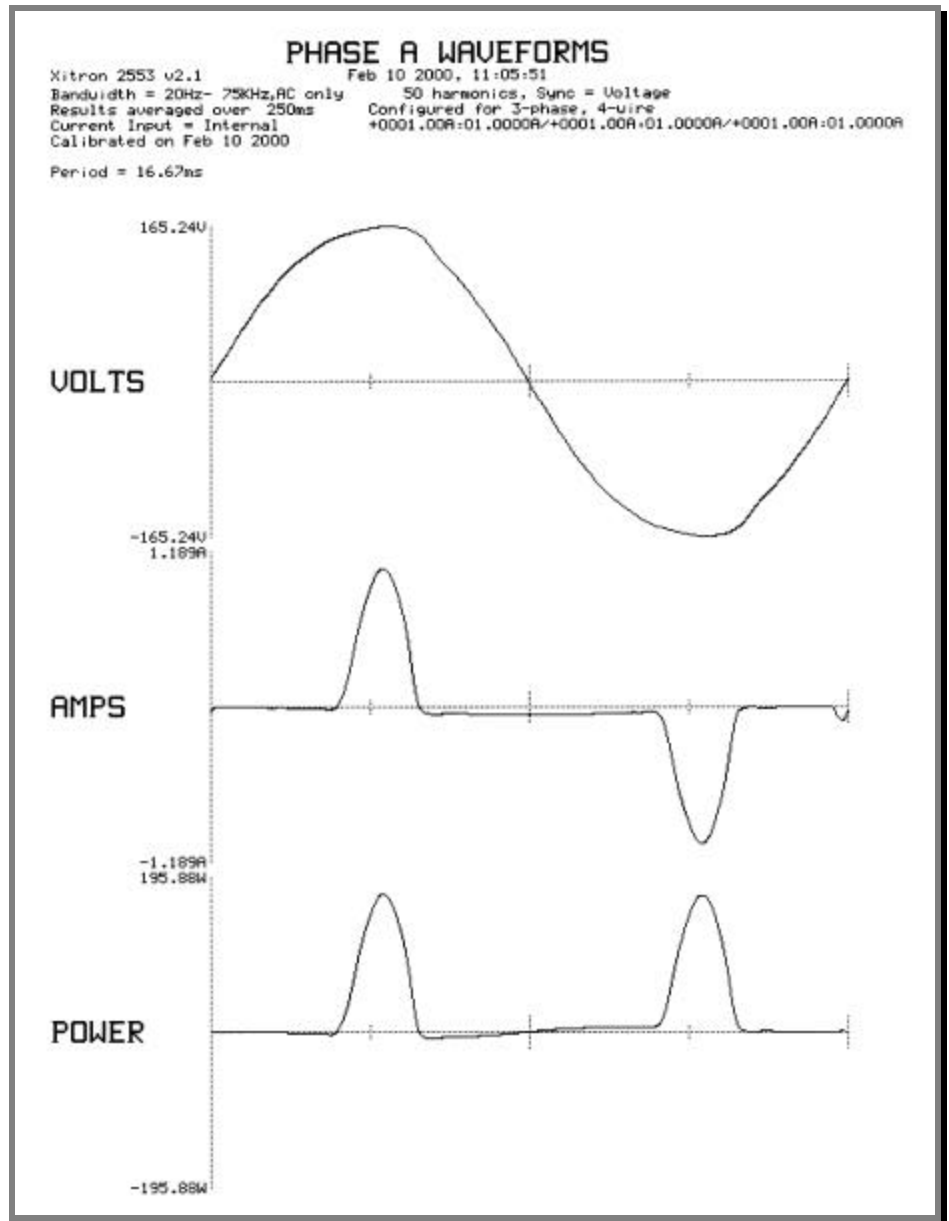

Figure 83. Phase A Waveforms graphic printout

To print the following, press the PRINT button from the **Waveforms V&A CONT** screen. For a phase A printout, as shown below, press PRINT when ϕA is displaying in the F3 position. Note that a printout for phases B and C will be similar. This sample printed with the analyser configured for a Text printer.

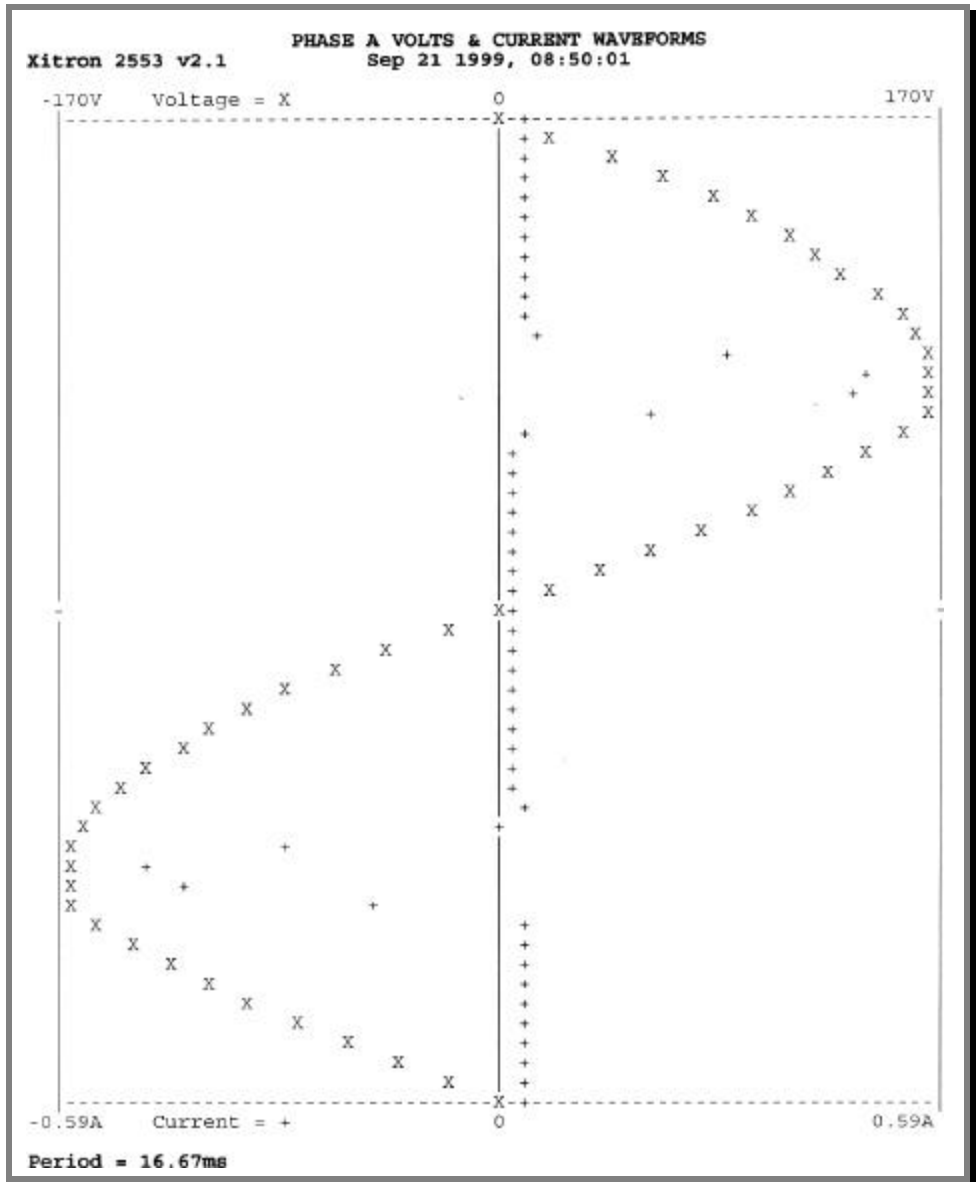

Figure 84. Phase A Volts and Current Waveforms nongraphic printout

For a similar printout, press the PRINT button from the **Waveforms** V&A CONT or V&W CONT screens. For a phase B printout, as shown below, press PRINT when ϕB is displaying in the F3 position. Note that a printout for phase C will be similar. Configure the analyser for a PCL2 printer.

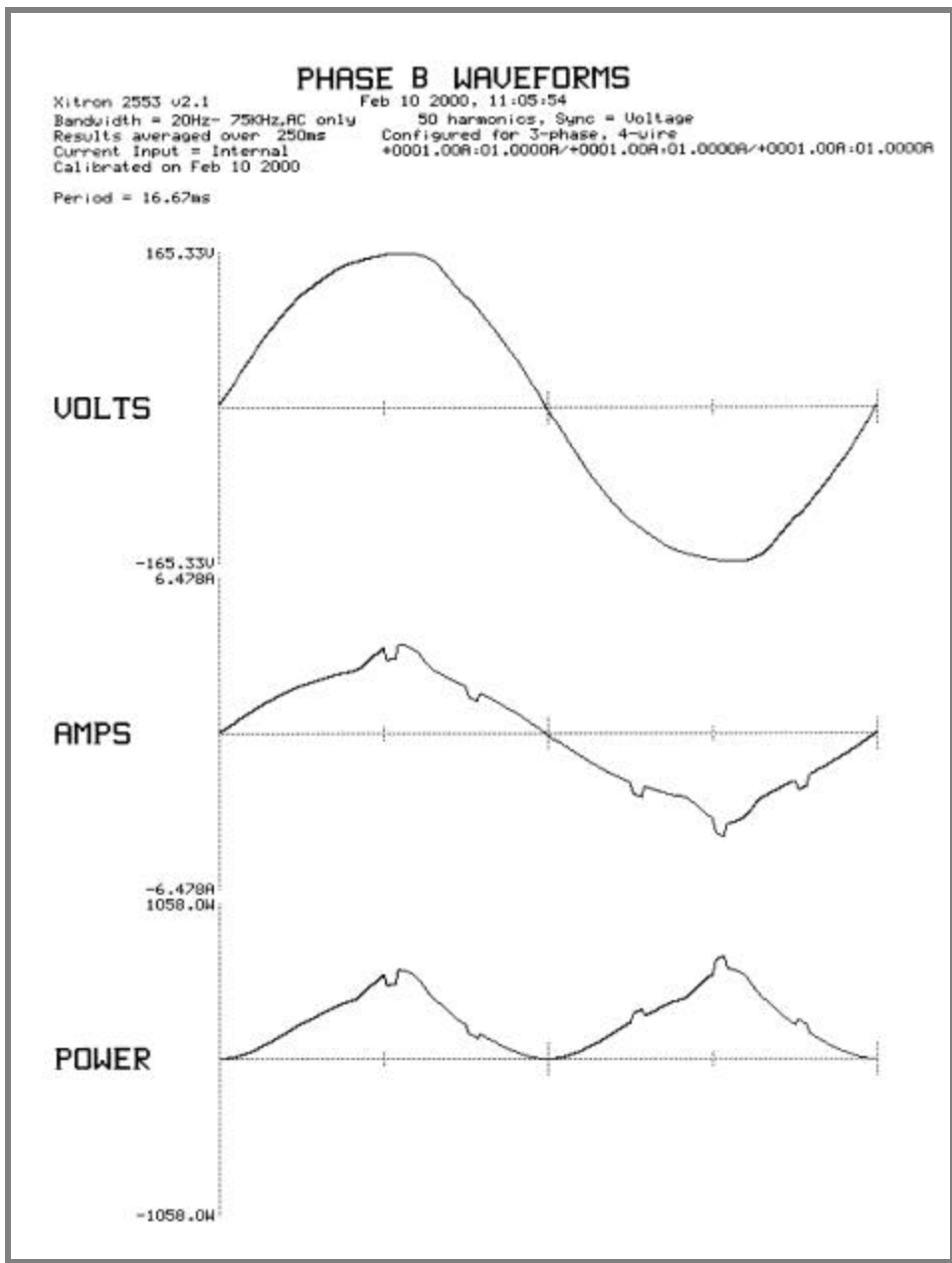

Figure 85. Phase B Waveforms graphic printout

For a similar printout, press the PRINT button from **Waveforms** V&A CONT or V&W CONT screens whenever ϕ ABC is showing in the F3 position. Configure the analyser for a PCL2 printer.

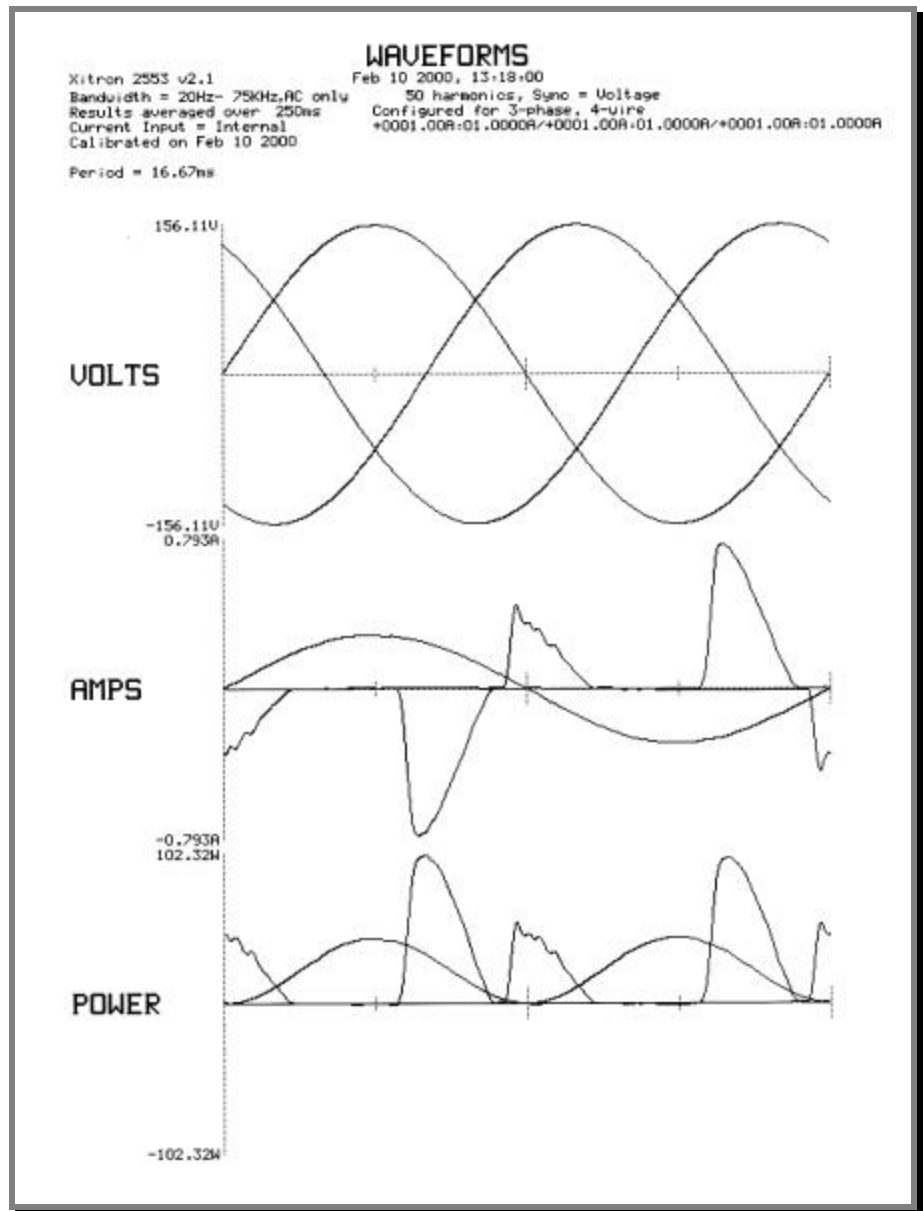

Figure 86. Waveforms Volts, Amps, Power graphic printout

Press the PRINT button from any one of the **History** display screens for a printout of the data being displayed. The printout shown below is from the History ϕ A Amps RMS display. Configure the analyser for a PCL2 printer.

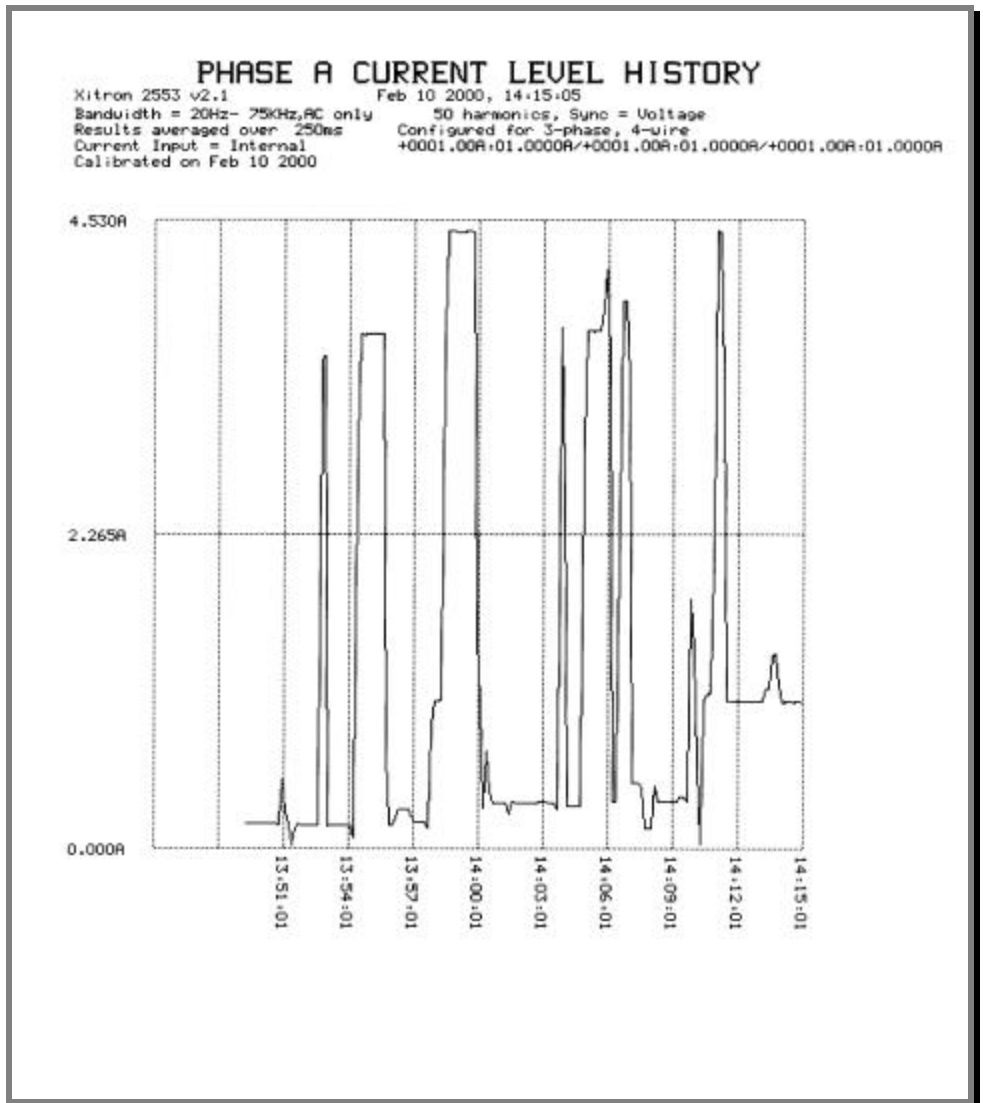

Figure 87. Phase A Current Level History graphic printout

Press the PRINT button from any one of the **History** display screens for a printout of the data being displayed. The printout shown below is from the History ϕ A Amps RMS display. This sample printed with the analyser configured for Text printer.

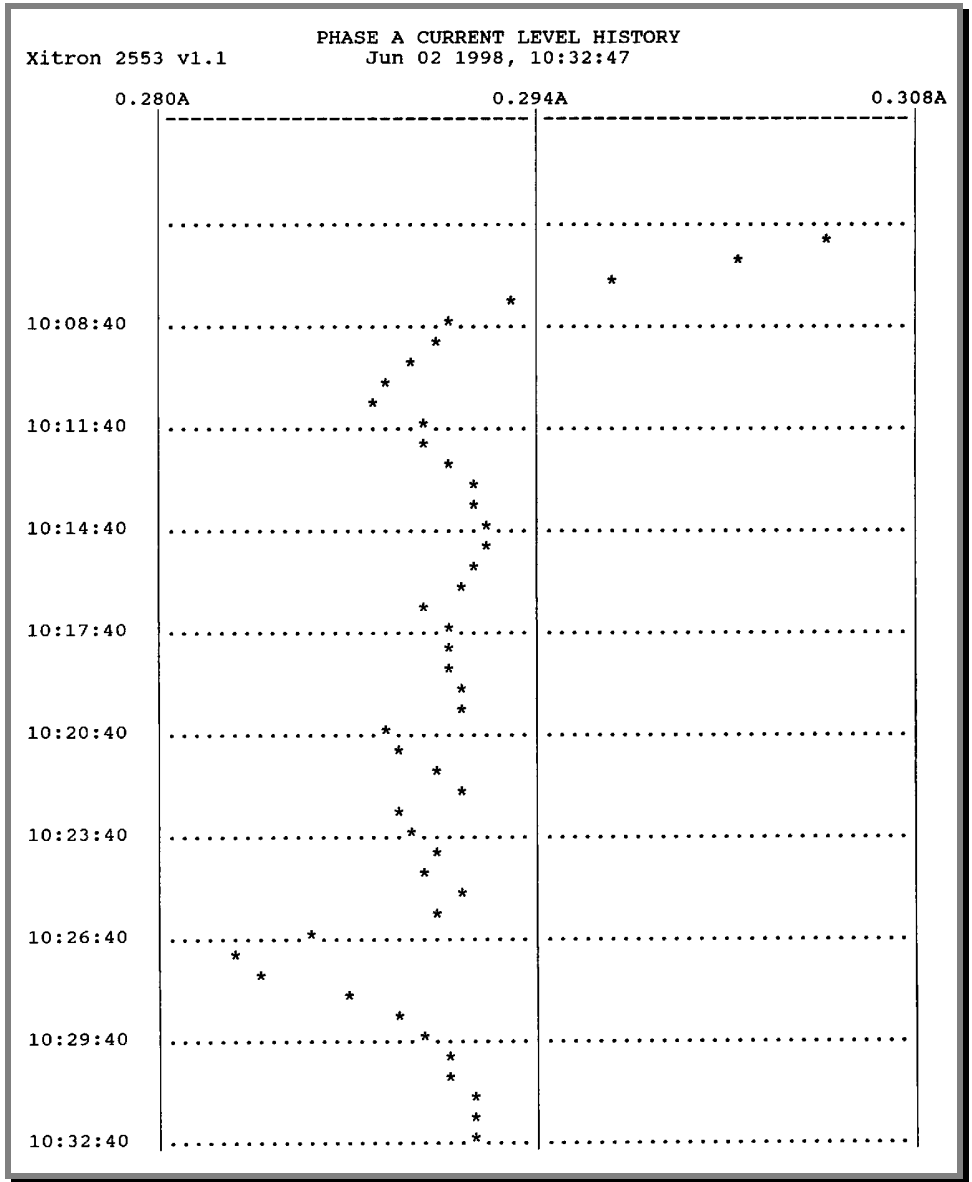

Figure 88. Phase A Current Level History nongraphic printout

Calibration

This chapter describes how to remove DC current offset and how to calibrate both the 2553 and 2553E. The calibration signal levels given are for 950V, 40A options. Other options will require different levels for calibration. Please refer to the **Product Options Fitted** screen accessible from the **Setup Index** to ensure you are applying the correct levels for your analyzer.

Removing DC Current Offsets

It is recommended that this procedure be performed at regular intervals and whenever large ambient temperature changes occur. Also, if Option E is fitted, perform this procedure when changing the external current transducer. Note that the DC Current Offset procedure must be applied to all (three) of the CURRENT INPUT SELECTIONS fitted in the 2553E.

1. From the **Setup Index** display, press the CURSOR button twice to highlight CURRENT INPUTS.



Figure 89. Setup Index screen with Current Inputs selected

2. Press the SETUP button. The presently selected INPUT SELECTION will be highlighted. Refer to illustration below.



Figure 90. Input Selection selected

3. Press the CHANGE button to select another INPUT SELECTION, as required.
 - For the 2553E: Internal, External Amps and External Volts
 - For the 2553: Internal
4. Press the DONE button.
5. Press the CURSOR button three times, the CALIBRATION choice is now highlighted.



Figure 91. Calibration selected

6. Press the SETUP button. The display changes to the Calibration Setup as shown below.



Figure 92. DC Zero Date selected

7. Ensure that there is no current flow in the selected current input (the voltages need not be removed).

8. Press the PERFORM key. Any DC offset in the current measurement is measured and subtracted from all future measurements. The date displayed next to DC ZERO changes to “today’s” date. Offsets are separately stored for each of the current input selections. Offsets up to 10% of the full-scale value for the respective current input can be accommodated.
9. Press the DONE key to return to the main **Setup Index** screen.

Calibrating the Power Analyser

The analyser is fully specified for one year of operation. Recommended maintenance includes an annual calibration and if Option E is fitted, calibrate when changing the external current transducer. A full calibration includes three calibration (cal) points: open circuit, voltage and current. Note that external calibration of the power analyser must be performed for all (three) of the CURRENT INPUT SELECTIONS fitted in the 2553E.

You can access all three cal points from the **Setup Index** display:

- The voltage cal point requires a calibrator that can drive a 2mA load at a minimum 0.025% accuracy and 0.01% short-term stability.
- The current cal point requires a calibrator that can drive a 200mV burden at a minimum 0.025% accuracy and 0.01% short-term stability.
- Use a Fluke 5700 multi-function calibrator or equivalent for calibrating the standard 2553/2553E. Use a Fluke 5725A or equivalent to calibrate the power analyser 40A Option.

Calibration Procedures

The user may calibrate the external current inputs with a user supplied current transducer connected, however the user should note that all calibrations are carried out at DC thus an inductive type transducer cannot be used during calibration. If a transducer is to be used, then for best results, use the nominal current transducer-scaling ratio. If the power analyser’s external current inputs are to be calibrated without an external transducer fitted, then the scale factor should be set to +1.0:1.0.

If Option E is fitted, then each of the Current Inputs (Internal, External Amps and External Volts). should be selected individually and the calibration procedure performed. The date shown as the last calibration date is the date that the presently selected Current Input was successfully calibrated.

Select the next appropriate INPUT SELECTION from the **Current Inputs** screen as described in *Removing DC Current Offsets* page 65.

Note: For a quick reference, when calibrating, refer to the *Calibration Connection Table* on page 76.

◆ **To access the Calibration Setup display—**

1. Return to the main **Setup Index** display using the NEXT button.
2. Press the CURSOR button three times, the CALIBRATION choice is now highlighted, as shown.



Figure 93. Calibration selected

3. Press the SETUP button. The display changes to the **Calibration Setup** display.
4. Press the CURSOR key, once. The date that the power analyser was last calibrated is now highlighted.



Figure 94. Calibration Date selected

◆ **To perform the open circuit point cal—**

1. Press PERFORM. The display for calibrating the Open Circuit for Internal and the External (Amps) will show: INPUT = ALL INPUTS OPEN CIRCUIT. The display for calibrating Open Circuit for External (Volts) will show: ALL TERMINALS OPEN, BNC SHORTED.

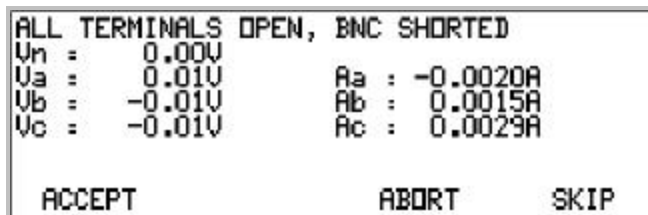

Figure 95. Open Circuit Point

2. Ensure that all wires from the source and load connectors on the back of the analyser have been removed.

Note: ESD and EMI noise can prevent registering zero values for open circuit calibration.

3. Press ACCEPT.
4. Wait one minute until the readings settle. The values for Vn, Va, Vb, Vc and Aa, Ab, Ac should zero out.

```

ALL INPUTS OPEN CIRCUIT
Un = 0.00V
Va = 0.00V      Aa : 0.000A
Vb = 0.00V      Ab : -0.000A
Vc = -0.00V     Ac : -0.000A

READINGS USING UPDATED CALIBRATION DATA
ACCEPT          ABORT          NEXT
  
```

Figure 96. Open Circuit Point Zero Readings

5. Press ACCEPT again and wait until the readings are within ± 0.1 .
6. Press NEXT when this step is complete.

If you choose *not* to perform the next cal point, press SKIP instead of NEXT.

Note: If you skip any of the three cal points, the calibration date in the **Setup Index** screen will not be updated.

Voltage Calibration

Depending on voltage option, the voltage cal point prompt will display—

INPUT = 400VDC SOURCE L & N TO CHASSIS

INPUT = 200VDC SOURCE L & N TO CHASSIS

INPUT = 120VDC SOURCE L & N TO CHASSIS

```

200VDC SOURCE ABCN(+) TO CHASSIS(-)
Un = -100.00%
Va = -100.00%      Aa :
Vb = -100.00%      Ab :
Vc = -100.00%     Ac :

WARNING! READING(S) OUTSIDE OF TOLERANCE
          GO BACK      ABORT      SKIP
  
```

Figure 97. Voltage Point initial display

WARNING: SHOCK HAZARD. LETHAL VOLTAGES OR CURRENT MAY BE PRESENT. ENSURE NO VOLTAGE OR CURRENT EXISTS ON THESE CONNECTIONS PRIOR TO ATTEMPTING TO CONNECT TO THESE INPUT TERMINALS.



◆ **To perform the internal voltage point cal—**

1. Connect the positive lead of the calibrator to the SOURCE A; B; C and N binding posts on the rear panel.
2. Connect the negative lead of the calibrator to the chassis binding post.
3. Apply the proper voltage input as shown on the display.

```

200VDC SOURCE ABCN(+) TO CHASSIS(-)
Vn = -100.00%
Va = -100.00%      Ra :
Vb = -100.00%      Ab :
Vc = -100.00%      Ac :
WARNING! READING(S) OUTSIDE OF TOLERANCE
          GO BACK      ABORT      SKIP
  
```

Figure 98. Internal Voltage Point display

4. Wait one minute for the V_n ; V_a ; V_b ; and V_c readings to settle and press ACCEPT.
5. Wait another minute for the readings to settle to 0 ± 0.1 and press ACCEPT.
6. Press NEXT when the readings are within specification.
7. Press SAVE DATA when all readings are within specification.



◆ **To perform the external voltage point cal—**

1. Connect the calibrator to the BNC of Phase A on the rear panel.
2. Apply the proper voltage input as shown on the display.

```

1.000ADC TO EXTERNAL TRANSDUCER A
1.000VDC TO BNC INPUT A
Va =                Ra : -100.20%
Vb =                Ab :
Vc =                Ac :
WARNING! READING(S) OUTSIDE OF TOLERANCE
          GO BACK      ABORT      SKIP
  
```

Figure 99. External Voltage Point Phase A

3. Wait one minute for the readings to settle and press ACCEPT.
4. Wait another minute for the readings to settle to 0 ± 0.1 and press ACCEPT.
5. Press NEXT when the readings are within specification.

6. Move the calibrator to the BNC of Phase B.

```
1.000ADC TO EXTERNAL TRANSDUCER B
1.000VDC TO BNC INPUT B
Ua :                               Aa :
Ub :                               Ab : -99.85%
Uc :                               Ac :
WARNING! READING(S) OUTSIDE OF TOLERANCE
          GO BACK      ABORT      SKIP
```

Figure 100. External Voltage Point Phase B

7. Repeat steps 2 through 5—apply proper voltage; wait for readings to settle to 0 ± 0.1 and press ACCEPT; wait another minute for readings to settle and press ACCEPT; press NEXT.
8. Move the calibrator lead to the BNC of Phase C.

```
1.000ADC TO EXTERNAL TRANSDUCER C
1.000ADC TO BNC INPUT C
Ua :                               Aa :
Ub :                               Ab :
Uc :                               Ac : -100.00%
WARNING! READING(S) OUTSIDE OF TOLERANCE
          GO BACK      ABORT      SKIP
```

Figure 101. External Voltage Point Phase C

9. Repeat steps 2 through 4—apply proper voltage; wait for readings to settle to 0 ± 0.1 and press ACCEPT; wait another minute for readings to settle and press ACCEPT.
10. Press SAVE DATA when all readings are within specification.

If you choose *not* to perform the next cal point, press SKIP instead of NEXT.

Note: If you skip any calibration points, the calibration date on the *Setup Index* display will not be updated.

Current Calibration

The current cal point display will show one of the following prompts, depending on option fitted—

INPUT = 2ADC SOURCE L TO LOAD L (8Apk Option)

INPUT = 10ADC SOURCE L TO LOAD L (40Apk Option)

Note: *The current level shown on the display depends upon which current input option is fitted.*

```

10ADC SOURCE A(+) TO LOAD A(-)
Un :
Ua :                Aa : -100.00%
Ub :                Ab :
Uc :                Ac :
WARNING! READING(S) OUTSIDE OF TOLERANCE
                GO BACK      ABORT      SKIP

```

Figure 102. Internal Current Cal Point display

WARNING: SHOCK HAZARD. LETHAL VOLTAGES OR CURRENT MAY BE PRESENT. ENSURE NO VOLTAGE OR CURRENT EXISTS ON THESE CONNECTIONS PRIOR TO ATTEMPTING TO CONNECT TO THESE INPUT TERMINALS.



◆ **To perform the internal current cal point—**

1. Connect the positive lead of the calibrator to SOURCE A binding post.
2. Connect the negative lead of the calibrator to the LOAD A binding post.
3. Apply the proper current input as shown on the display.

```

10ADC SOURCE A(+) TO LOAD A(-)
Un :
Ua :                Aa : -100.00%
Ub :                Ab :
Uc :                Ac :
WARNING! READING(S) OUTSIDE OF TOLERANCE
                GO BACK      ABORT      SKIP

```

Figure 103. Load "A" Current Cal Point display

4. Wait one minute for the readings Aa to settle and press ACCEPT.
5. Wait one minute for the readings to settle to 0 ± 0.1 and press ACCEPT.
6. Press NEXT when the readings are within specification. The following screen will display.

```

LOADC SOURCE B(<+) TO LOAD B(<-)
Un =
Ua =                Aa :
Ub =                Ab : -100.00%
Uc =                Ac :
WARNING! READING(S) OUTSIDE OF TOLERANCE
          GO BACK      ABORT      SKIP

```

Figure 104. Load "B" Current Cal Point display

7. Move the positive lead of the calibrator to SOURCE B binding post.
8. Move the calibrator negative lead to the LOAD B binding post.
9. Repeat steps 3 through 6—apply proper current; wait for readings Ab to settle to 0 ± 0.1 and press ACCEPT; wait another minute for readings to settle and press ACCEPT. Press NEXT and the following screen will display.

```

LOADC SOURCE C(<+) TO LOAD C(<-)
Un =
Ua =                Aa :
Ub =                Ab :
Uc =                Ac : -100.00%
WARNING! READING(S) OUTSIDE OF TOLERANCE
          GO BACK      ABORT      SKIP

```

Figure 105. Load "C" Current Cal Point display

10. Move the calibrator positive lead to the SOURCE C binding post.
11. Move the calibrator negative lead to the LOAD C binding post.
12. Repeat steps 3 through 5—apply proper current; wait for readings Ac to settle to 0 ± 0.1 and press ACCEPT; wait another minute for readings to settle and press ACCEPT.

13. The screen will read:

```

1.000ADC SOURCE C(+>) TO LOAD C(->)
Un :
Va :                Aa :
Vb :                Ab :
Vc :                Ac : 0.041%
ALL CALIBRATIONS SUCCESSFULLY COMPLETED
READINGS USING UPDATED CALIBRATION DATA
ACCEPT  GO BACK  ABORT  SAVE DATA

```

Figure 106. Internal Current Calibration Completion display

14. Press SAVE DATA when this step is complete.
 15. Press DONE.



◆ **To perform the external current cal point—**

1. Connect the calibrator to the BNC of Phase A.
2. Apply the proper current input as shown on the display.

```

1.000ADC TO EXTERNAL TRANSDUCER A
1.000ADC TO BNC INPUT A
Va :                Aa : -100.00%
Vb :                Ab :
Vc :                Ac :
WARNING! READING(S) OUTSIDE OF TOLERANCE
GO BACK  ABORT  SKIP

```

Figure 107. External Transducer A Current Cal Point display

3. Wait one minute for the Aa readings to settle and press ACCEPT.
4. Wait one minute for the readings to settle to 0 ± 0.1 and press ACCEPT.
5. Press NEXT when the readings are within specification.
6. Move the calibrator to the BNC of Phase B.

```

1.000ADC TO EXTERNAL TRANSDUCER B
1.000ADC TO BNC INPUT B
Va :                Aa :
Vb :                Ab : -100.00%
Vc :                Ac :
WARNING! READING(S) OUTSIDE OF TOLERANCE
GO BACK  ABORT  SKIP

```

Figure 108. External Transducer B Current Cal Point display

7. Repeat steps 2 through 5— apply proper current; wait for readings Ab to settle to 0 ± 0.1 and press ACCEPT; wait another minute for readings to settle and press ACCEPT; press NEXT.
8. Move the calibrator to the BNC of Phase C.

```
1.000ADC TO EXTERNAL TRANSDUCER C
1.000ADC TO BNC INPUT C
Ua :                               Aa :
Ub :                               Ab :
Uc :                               Ac : -100.00%

WARNING! READING(S) OUTSIDE OF TOLERANCE
                GO BACK      ABORT      SKIP
```

Figure 109. External Transducer C Current Cal Point display

9. Repeat steps 2 through 5— apply proper current; wait for readings Ac to settle to 0 ± 0.1 and press ACCEPT; wait another minute for readings to settle and press ACCEPT; press NEXT.
10. Press SAVE DATA when the readings are within specification.
11. Press DONE.

Note: *If you have not skipped any steps, then the present date will automatically replace the previous CALIBRATED date for the selected CURRENT INPUT.*

Calibration Faults

In the event of a calibration fault, please check the connections to the calibrator and the analyser before attempting calibration again. If you are unable to correct a fault condition, contact Vitrek for assistance and/or request a return merchandise authorization (RMA) number. Refer to the front section of this guide for telephone number, address and e-mail address of Vitrek.

Important Note: *Opening the Power Analyser's case may void your warranty.*

Calibration Connection Table

3-Phase Internal Voltage Connections		3-Phase External Voltage Connections	
Calibrator Lead	Rear Panel	Calibrator Lead*	Rear Panel
Negative	Chassis ground	Negative	Coax Shield
Positive	SOURCE A; N; B; C	Positive	EXTERNAL A (bnc)— Center conductor of coax
		Negative	Coax Shield
		Positive	EXTERNAL B (bnc)— Center conductor of coax
		Negative	Coax Shield
		Positive	EXTERNAL C (bnc)— Center conductor of coax

3-Phase Internal Current Connections		3-Phase External Current Connections	
Calibrator Lead	Rear Panel	Calibrator Lead*	Rear Panel
Negative	LOAD A	Amp	External transducer
Positive	SOURCE A; B; C	Volt	EXTERNAL A (bnc)
Negative	LOAD B	Amp	External transducer
Positive	SOURCE A; B; C	Volt	EXTERNAL B (bnc)
Negative	LOAD C	Amp	External transducer
Positive	SOURCE A; B; C	Volt	EXTERNAL C (bnc)

*Option for user: External calibration may be performed using a non-inductive external transducer.

Appendix A - Physical Specifications

For further details regarding a specific application contact Vitrek or its representative. Refer also to *Appendix B - Measurement Specifications*.

Note: *Specifications subject to change without notice.*

Temperature & Humidity

Operating: 0°C to 45°C, <85% RH @ 40°C non-condensing

Storage: -30°C to 65°C, <95% RH @ 40°C non-condensing

Size & Weight

Size: (HxWxD) 4½" x 11½" x 10½"

Weight: 6lbs. (2.7kg)

Power Input

Voltage: 80-265Vrms (auto-selecting)

Frequency: 50/60/400Hz @ 25VA max.

Appendix B - Measurement Specifications

Unless otherwise indicated, all performance specifications are valid throughout the specified operating temperature range, for a period of 1 year, following a 15 minute warm-up period.

Where “typical” specifications are given, the specification is guaranteed for a typical application (115V/230Vrms with a current > 10% range), for further details regarding a specific application contact Vitrek or its representative. Refer also to *Appendix A - Physical Specifications*.

Note: *Specifications subject to change without notice.*

Power Source Capabilities (Option E only)

Output Voltage	+ and – 15V (within 0.5V)
Source Impedance	5?
Maximum Load	100mA

Input Signal Capabilities

Binding Post Signal Terminals

Voltage (950V option)	2500Vpk for 1s, 675Vrms continuous, 950Vpk measurable
Voltage (1500V option)	2500Vpk for 1s, 875Vrms continuous, 1500Vpk measurable
Voltage (400V option)	2500Vpk for 1s, 425Vrms continuous, 400Vpk measurable
Current (8A option)	25Arms for 50ms, 10Arms continuous, 8Apk measurable
Current (40A option)	125Arms for 50ms, 25Arms continuous, 40Apk measurable

BNC Signal Terminals (Option E only)

Common Mode	5Vpk maximum to Chassis
Voltage	25Vpk for 50ms, 2.5Vrms continuous, 2.5Vpk measurable
Current	10Arms for 50ms, 2.5Arms continuous, 5Apk measurable

Input Burden

All capacitances shown are typical values.

Binding Post Signal Terminals

To Chassis (400V option)	243K Ω 60pF
To Chassis (950V option)	600K Ω 60pF
To Chassis (1500V option)	1M Ω 60pF
Source to Load (8A option)	< 50m Ω
Source to Load (40A option)	< 15m Ω

BNC Signal Terminals (Option E only)

VOLTAGE Mode

To Chassis	100K Ω 5pF
Signal	100K Ω 5pF

CURRENT Mode

To Chassis	50 Ω 5pF
Signal	< 100m Ω

Measurement Accuracy

Unless otherwise shown, all percentages are percentage of the reading.

When including DC signal content, add DC Measurement Accuracy if total signal is less than 0.5% full-scale for option, or if DC component is greater than AC component.

When using an external current transducer, the specifications for that transducer should be added to the power analyser specifications to obtain the overall specifications.

Voltage (Option 400V)

DC	0.1% (0.25% above 250V) + 0.1V
0.02Hz to 20Hz range	0.1% (0.25% above 250V) + 0.02V + 0.1%/Hz add 0.15% below 0.04Hz if AC coupled add 0.075V for peak measurements
0.2Hz to 200Hz range	0.1% (0.25% above 250V) + 0.02V + 0.01%/Hz add 0.05% below 0.4Hz if AC coupled add 0.075V for peak measurements
2Hz to 2KHz range	0.1% (0.25% above 250V) + 0.02V + 0.001%/Hz add 0.05% below 4Hz if AC coupled add 0.075V for peak measurements
20Hz to 5KHz range	0.1% (0.25% above 250V) + 0.025V + 0.4%/KHz add 0.05% below 40Hz if AC coupled add 0.3V for peak measurements
20Hz to 75KHz range	0.1% (0.25% above 250V) + 0.05V + 0.02%/KHz add 0.1% below 40Hz if AC coupled add 0.5V for peak measurements
Common Mode	>70dB decreasing linearly to >40dB at 75KHz
Current to Voltage Crosstalk	typically negligible
Voltage to Voltage Crosstalk	>120dB decreasing linearly to >80dB at 75KHz
Phase (to other phase)	0.1° + 0.025°/KHz

Voltage (Option 950V)

DC	0.1% (0.25% above 400V) + 0.15V
0.02Hz to 20Hz range	0.1% (0.25% above 400V) + 0.025V + 0.1%/Hz add 0.15% below 0.04Hz if AC coupled add 0.1V for peak measurements
0.2Hz to 200Hz range	0.1% (0.25% above 400V) + 0.025V + 0.01%/Hz add 0.05% below 0.4Hz if AC coupled add 0.1V for peak measurements
2Hz to 2KHz range	0.1% (0.25% above 400V) + 0.03V + 0.001%/Hz add 0.05% below 4Hz if AC coupled add 0.15V for peak measurements
20Hz to 5KHz range	0.1% (0.25% above 400V) + 0.05V + 0.4%/KHz add 0.05% below 40Hz if AC coupled add 0.5V for peak measurements

20Hz to 75KHz range	0.1% (0.25% above 400V) + 0.1V + 0.02%/KHz add 0.1% below 40Hz if AC coupled add 1V for peak measurements
Common Mode	>70dB decreasing linearly to >40dB at 75KHz
Current to Voltage Crosstalk	typically negligible
Voltage to Voltage Crosstalk	>120dB decreasing linearly to >80dB at 75KHz
Phase (to other phase)	$0.1^\circ + 0.025^\circ/\text{KHz}$

Voltage (Option 1500V)

DC	0.1% (0.25% above 500V) + 0.3V
0.02Hz to 20Hz range	0.1% (0.25% above 500V) + 0.05V + 0.1%/Hz add 0.15% below 0.04Hz if AC coupled add 0.2V for peak measurements
0.2Hz to 200Hz range	0.1% (0.25% above 500V) + 0.05V + 0.01%/Hz add 0.05% below 0.4Hz if AC coupled add 0.2V for peak measurements
2Hz to 2KHz range	0.1% (0.25% above 500V) + 0.075V + 0.001%/Hz add 0.05% below 4Hz if AC coupled add 0.3V for peak measurements
20Hz to 5KHz range	0.1% (0.25% above 500V) + 0.1V + 0.4%/KHz add 0.05% below 40Hz if AC coupled add 1V for peak measurements
20Hz to 75KHz range	0.1% (0.25% above 500V) + 0.15V + 0.04%/KHz add 0.1% below 40Hz if AC coupled add 2V for peak measurements
Common Mode	>70dB decreasing linearly to >35dB at 75KHz
Current to Voltage Crosstalk	typically negligible
Voltage to Voltage Crosstalk	>110dB decreasing linearly to >60dB at 75KHz
Phase (to other phase)	$0.1^\circ + 0.05^\circ/\text{KHz}$

Internal Current (Option 8A)

DC	0.1% + 0.005A
0.02Hz to 20Hz range	0.1% + 0.005A + 0.1%/Hz add 0.15% below 0.04Hz if AC coupled add 0.02A for peak measurements

0.2Hz to 200Hz range	0.1% + 0.005A + 0.01%/Hz add 0.05% below 0.4Hz if AC coupled add 0.02A for peak measurements
2Hz to 2KHz range	0.1% + 0.005A + 0.001%/Hz add 0.05% below 4Hz if AC coupled add 0.02A for peak measurements
20Hz to 5KHz range	0.1% + 0.005A + 0.4%/KHz add 0.05% below 40Hz if AC coupled add 0.04A for peak measurements
20Hz to 75KHz range	below 10KHz : 0.1% + 0.01A + 0.4%/KHz 10KHz to 40KHz : 0.03A + 0.4%/KHz above 40KHz : 16% + 0.03A add 0.1% below 40Hz if AC coupled add 0.1A for peak measurements
Common Mode	0.000001A / V / KHz (i.e. 0.0002A per KHz at 230V)
Current to Current Crosstalk	>80dB decreasing linearly to >50dB at 75KHz
Phase (to other phase)	0.1° + 0.05°/KHz
Phase (to Voltage)	0.1° + 0.05°/KHz add 1° for frequencies 1KHz to 10KHz

Internal Current (Option 40A)

DC	0.1% + 0.025A
0.02Hz to 20Hz range	0.1% + 0.025A + 0.1%/Hz add 0.15% below 0.04Hz if AC coupled add 0.1A for peak measurements
0.2Hz to 200Hz range	0.1% + 0.025A + 0.01%/Hz add 0.05% below 0.4Hz if AC coupled add 0.1A for peak measurements
2Hz to 2KHz range	0.1% + 0.025A + 0.001%/Hz add 0.05% below 4Hz if AC coupled add 0.1A for peak measurements
20Hz to 5KHz range	0.1% + 0.025A + 0.4%/KHz add 0.05% below 40Hz if AC coupled add 0.2A for peak measurements

20Hz to 75KHz range	below 10KHz : 0.1% + 0.05A + 0.4%/KHz 10KHz to 40KHz : 0.15A + 0.4%/KHz above 40KHz : 16% + 0.15A add 0.1% below 40Hz if AC coupled add 0.5A for peak measurements
Common Mode	0.000005A / V / KHz (i.e. 0.001A per KHz at 230V)
Current to Current Crosstalk	>75dB decreasing linearly to >45dB at 75KHz
Phase (to other phase)	$0.1^\circ + 0.05^\circ/\text{KHz}$
Phase (to Voltage)	$0.1^\circ + 0.05^\circ/\text{KHz}$ add 1° for frequencies 1KHz to 10KHz

External Current (Option E, voltage input)

DC	0.1% + 0.0005V
0.02Hz to 20Hz range	0.1% + 0.0001V + 0.1%/Hz add 0.15% below 0.04Hz if AC coupled add 0.0005V for peak measurements
0.2Hz to 200Hz range	0.1% + 0.0001V + 0.01%/Hz add 0.05% below 0.4Hz if AC coupled add 0.0005V for peak measurements
2Hz to 2KHz range	0.1% + 0.0001V + 0.001%/Hz add 0.05% below 4Hz if AC coupled add 0.0005V for peak measurements
20Hz to 5KHz range	0.1% + 0.00015V + 0.4%/KHz add 0.05% below 40Hz if AC coupled add 0.0015V for peak measurements
20Hz to 75KHz range	0.1% + 0.00025V + 0.02%/KHz add 0.1% below 40Hz if AC coupled add 0.0025V for peak measurements
Common Mode	>60dB decreasing linearly to >40dB at 75KHz
Current to Current Crosstalk	>120dB decreasing linearly to >80dB at 75KHz
Phase (to other phase)	$0.1^\circ + 0.05^\circ/\text{KHz}$
Phase (to Voltage)	$0.1^\circ + 0.05^\circ/\text{KHz}$

External Current (Option E, current input)

DC	0.1% + 0.01A
0.02Hz to 20Hz range	0.1% + 0.002A + 0.1%/Hz add 0.15% below 0.04Hz if AC coupled add 0.01A for peak measurements
0.2Hz to 200Hz range	0.1% + 0.002A + 0.01%/Hz add 0.05% below 0.4Hz if AC coupled add 0.01A for peak measurements
2Hz to 2KHz range	0.1% + 0.002A + 0.001%/Hz add 0.05% below 4Hz if AC coupled add 0.01A for peak measurements
20Hz to 5KHz range	0.1% + 0.003A + 0.4%/KHz add 0.05% below 40Hz if AC coupled add 0.03A for peak measurements
20Hz to 75KHz range	0.1% + 0.005A + 0.02%/KHz add 0.1% below 40Hz if AC coupled add 0.05A for peak measurements
Phase (to Voltage)	0.1° + 0.05°/KHz
Phase (to other phase)	0.1° + 0.05°/KHz
Current to Current Crosstalk	>100dB decreasing linearly to >70dB at 75KHz

VA

(Applied Voltage) x Current Accuracy + (Applied Current) x Voltage Accuracy

Power Factor

Combination of phase and crosstalk specifications

At 115 or 230Vrms (current >10% range for option fitted) -

PF =	1.0000	0.9000	0.7000	0.5000	0.3000	0.1000	0.0000
@ 50/60Hz	0.0001	0.0008	0.0013	0.0016	0.0017	0.0018	0.0018
@ 400Hz	0.0001	0.0009	0.0015	0.0018	0.0020	0.0021	0.0021
@ 30KHz	0.0005	0.0218	0.0318	0.0341	0.0329	0.0295	0.0273
@ 75KHz	0.0056	0.0725	0.1014	0.1068	0.1015	0.0897	0.0822

DC Power

(Applied Voltage) x Current Accuracy + (Applied Current) x Voltage Accuracy

AC Power

Combination of (Voltage x Current Accuracy), (Current x Voltage Accuracy), and phase specifications

At 115 or 230Vrms (current >10% range for option fitted, external current) -

PF =	1.0000	0.9000	0.7000	0.5000	0.3000	0.1000	0.0000
@ 50/60Hz	0.2%	0.3%	0.4%	0.5%	0.8%	2.0%	0.2% VA
@ 400Hz	0.2%	0.3%	0.4%	0.6%	0.8%	2.3%	0.23% VA
@ 30KHz	1.5%	3.1%	4.8%	6.9%	11%	30%	3.0% VA
@ 75KHz	4.6%	9.9%	15%	20%	33%	10% VA	10.0% VA

VAR

Combination of (Voltage x Current Accuracy), (Current x Voltage Accuracy), phase accuracy, and common-mode

At 115 or 230Vrms (current >10% range for option fitted, external current, accuracy % of VAR reading) -

PF =	1.0000	0.9000	0.7000	0.5000	0.3000	0.1000	0.0000
@ 50/60Hz	0.2% VA	1.1%	0.5%	0.3%	0.3%	0.2%	0.2%
@ 400Hz	0.2% VA	1.2%	0.5%	0.4%	0.3%	0.2%	0.2%
@ 30KHz	1.0% VA	13%	4.5%	2.8%	2.1%	1.6%	1.4%
@ 75KHz	5% VA	40%	14%	8.3%	6%	4.4%	4.2%

Harmonics

In the following 'N' denotes a harmonic number.

Minimum Fundamental	1% of full-scale for selected synchronization source
Number Harmonics	50 or 40KHz/fundamental frequency (whichever smaller)
Absolute Harmonics	As signal accuracy + (0.05% x N)
Relative Harmonics	0.1% + 0.04%/KHz
Total Distortion	0.1% at line frequencies
Inter-Harmonic Phase	0.1° + 0.2°/KHz (harmonic > 0.1% full-scale)

Frequency

Minimum Input	0.5% of range for Option for input selected
Measurement Accuracy	0.05% (sampling synchronized to within 0.01%)
Measurement Period	100ms or 1 cycle (whichever longer)

Integrated Results

Accuracy of integrated result + 0.05% + 10ms

Crest Factor

Accuracy	From accuracy of peak results
Range	1 to 999

Form Factor

Accuracy	From accuracy of amplitude results
Range	1 to 999

Load K-Factor

Accuracy	From accuracy of harmonics results, typical accuracy within 0.02 at line frequencies.
Range	1 to 999

Waveforms

Number of points per cycle	400 (nominally 0.4° accuracy)
Amplitude Accuracy	As relevant peak accuracy

History

Timing Accuracy	0.05% + 10ms
Timing Resolution	5% of a division
Result Accuracy	As the result
Filtering	Non-peak results averaged over 5% of a division, peak results have continuous coverage within each 5% of a division at all frequencies
Depth	10 divisions

Timing (per division)

0.4 seconds, 1 second, 2 seconds, 5 seconds, 10 seconds, 30 seconds, 1 minute, 3 minutes, 10 minutes, 30 minutes, 1 hour, 3 hours, 6 hours, 12 hours, 1 day (user selectable)