



By **VITREK**

# RazorPlus Express Digitizer

16-Bit / 14-Bit, 2-CHs @ 500 MS/s, PCIe Gen3 x8



## ABOUT US

Since 1987, GaGe is a worldwide industry leader in high-speed data acquisition solutions featuring a portfolio of the highest performance Digitizers, PC oscilloscope software, powerful SDKs for custom application development, and turnkey integrated PC-based measurement systems.

GaGe is a product brand of Vitrek, a USA fully accredited ISO 9001:2015 quality certified and ISO 17025 calibration certified company.



## APPLICATIONS

- Wideband Signal Analysis
- Wideband Stimulus / Response Test
- Satellite Communications Test
- Radar Design and Test
- Electronic Warfare (EW) Test
- Signals Intelligence (SIGINT)
- Spectrum Monitoring
- Ultrasound Imaging
- Non-Destructive Testing (NDT)
- Mass Spectroscopy
- Time of Flight (ToF)
- Light Detection and Ranging (LiDAR)
- Life Sciences
- Particle Physics

## FEATURES

- 16-Bit or 14-Bit Vertical A/D Resolution with 2 Digitizing Input Channels
- 500 MS/s Maximum Sampling Rate per Channel
- 30 Software Selectable A/D Sampling Rates from 1 kS/s to 500 MS/s
- Front-End with DC Coupling (AC Optional) and 50  $\Omega$  / 1M  $\Omega$  Inputs
- Dedicated Set of 50  $\Omega$  Input Channel Pair and 1M  $\Omega$  Input Channel Pair
- 250 MHz Bandwidth @ 50  $\Omega$  Inputs / 150 MHz Bandwidth @ 1M  $\Omega$  Inputs
- 4 GS (8 GB) Onboard Dual-Port Sample Memory Standard
- 6 GB/s PCIe Gen3 x8 Transfer Rate off Onboard Memory
- 2 GB/s PCIe Gen3 x8 Real-Time Sustained Streaming Rate to Host
- Stream Acquired Signal Data to GPU for In-Line Processing in Real-Time
- Stream Acquired Signal Data to Storage for Real-Time Recordings
- Ease of Integration with External or Reference Clock In & Clock Out
- External Trigger In & Trigger Out with Advanced Triggering Operations
- Programming-Free Operation with GaGeScope PC Oscilloscope
- Programming-Free IF Recording & Playback with DsScope
- Programming-Free RF Recording & Playback with SpectraScopeRT
- Software Development Kits for C/C#, Python, LabVIEW, & MATLAB
- Windows 11/10 and Linux Operating Systems Supported

### RazorPlus Express CompuScope Simplified Block Diagram

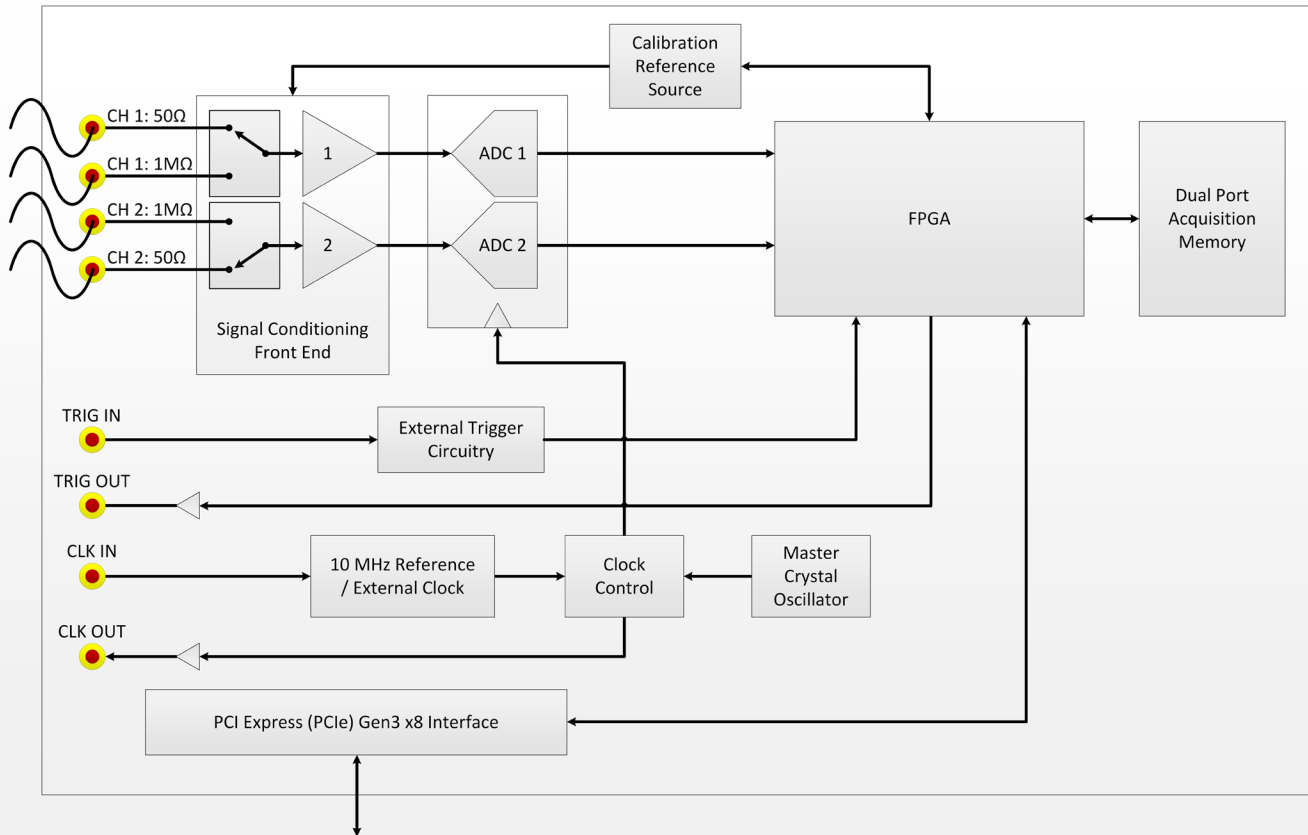

#### Analog Input Front End

The RazorPlus Express is available in dual channel models supporting a maximum A/D sampling rate up to 500 MS/s. ADC data can be captured in dual channel or single channel modes with six software selectable input voltage ranges at  $\pm 100$  mV,  $\pm 200$  mV,  $\pm 500$  mV,  $\pm 1$  V,  $\pm 2$  V, and  $\pm 5$  V.

The RazorPlus has separate physical input channels that differ for input impedance. There is a pair of input channels that are dedicated to 50  $\Omega$  input impedance connections, and a pair of input channels that are dedicated to 1M  $\Omega$  input impedance connections. All input channels are fixed for DC-coupling.

The analog input bandwidth is 250 MHz with 50  $\Omega$  input impedance or 150 MHz with 1M  $\Omega$  input impedance. The wider 250 MHz bandwidth is especially useful for RF based applications by enabling direct RF sampling of wider band signals.

AC-coupling is useful for applications in which a small AC signal is sitting upon a large DC bias. In these cases, the DC bias can be removed with AC-coupling to reduce the input range for better signal fidelity. A configuration for fixed AC-coupling for the input channels is available as an option. The coupling front end is factory hardware configured and is not software switchable.

Note that it is also possible to externally implement AC-coupling with the use of an external high-pass filter; in which case the fixed AC-coupling hardware configuration is not required.

#### ADC Clock Circuit

The RazorPlus Express utilizes an onboard fixed master crystal oscillator as the primary internal clock source for the ADCs combined with clock control to effectively produce 30 software selectable A/D sampling rates ranging from 1 kS/s to 500 MS/s with a rate accuracy of  $\pm 1$  Part Per Million (PPM).

The ADC clock can also be supplied by an external clock input source, allowing for variable clock sample frequencies from 250 MS/s to 500 MS/s. External clock input signals are routed almost directly to the ADC chips so that each clock edge causes the ADC chips to produce exactly one sample. No re-clocking or Phase Lock Loop circuitry is used since these methods may lead to extra or missing ADC clocks.

Use of an external clocking signal that is synchronous with the signal to be acquired achieves the best possible trigger stability with intrinsic jitter typically  $\frac{1}{4}$  of a data point or better. Compared to using an internal clock source that is asynchronous (unrelated) to the signal trigger that can result in a 1-point trigger jitter between acquisitions.

When using an external clock source, the external clock frequency must be twice the targeted A/D sampling rate frequency. For example, to target an A/D sampling rate of 450 MS/s, the external clock source frequency must be set to 900 MHz.

When internally clocking, the ADC clocking signal is produced by a Voltage Controlled Crystal Oscillator (VCXO) within an on-board Phase Lock Loop (PLL) circuit. The PLL is disciplined by an on-board 10 MHz reference signal that has a frequency accuracy of order  $\pm 1$  PPM. This circuitry ensures that the frequency of the VCXO is reset every 100 nanoseconds so that the ADC sampling clock inherits the accuracy and stability of the 10 MHz reference input.

The  $\pm 1$  PPM internal sampling rate accuracy is sufficient for most digitizer applications. However, some applications (notably communications), require ultra-high ADC clocking accuracy and stability. External atomic or IRIG sources can provide 10 MHz reference frequency accuracies and stabilities that are measured in Parts-Per-Billion. For these requirements, an external 10 MHz reference clocking signal source can be applied to the external clock input. Activating reference clocking from the controlling software will switch the PLL/VXCO input from the digitizer's 10 MHz reference signal to the supplied external 10 MHz reference signal. The ADC sampling will then inherit the accuracy and stability of the supplied external 10 MHz reference signal.

A clock output connector can be used to provide a clock out signal to serve as an external clocking source for other external devices. The clock out signal frequencies range from 250 MHz to 500 MHz or can be configured to output the onboard 10 MHz reference signal.

### Acquisition Memory

The RazorPlus Express includes 4 GS (8 GB) of onboard acquisition sample memory. The onboard acquisition memory size is shared and equally divided among all active input channels (2 or 1) when acquiring data to onboard memory.

With the optional eXpert PCIe Data Streaming FPGA Firmware package, the dual-port architecture of the onboard memory is utilized as a large FIFO buffer for streaming acquired data to host PC memory via the digitizer's PCIe Gen3 x8 interface at sustained rates up to 2 GB/s supporting the maximum sampling rate for both channels:

$$2\text{-CHs} * 500 \text{ MS/s per CH} * 2 \text{ bytes per 16-bit sample} = 2 \text{ GB/s}$$

The data streaming rate is the same for the 14-bit option model, as the 14-bit data is effectively padded to 16-bit with 2-bits of 0.

### Triggering

Advanced triggering operations include Simple, Complex, Windowed, and Multi-channel Boolean ORed.

Simple triggering uses a single trigger source from any input channel, external trigger, or software with software controls for trigger level and trigger slope (positive or negative). Each time the

selected trigger source signal crosses the set trigger level with set trigger slope, a digital trigger is generated to initiate acquisition.

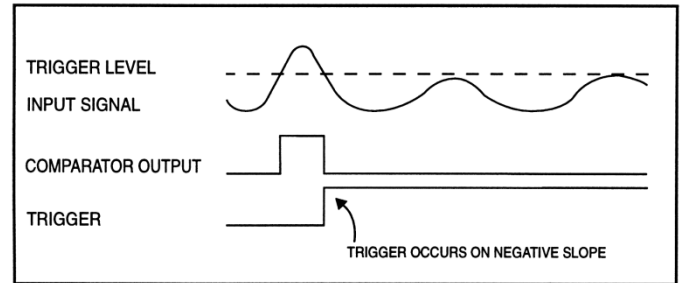

**Figure: Generation of a Trigger Signal – Negative Slope**

To avoid triggering on noise, the RazorPlus Express features a trigger sensitivity value of  $\pm 2\%$  of Full-Scale Input Range (FSIR) of the trigger source. This value specifies the minimum amount by which the trigger signal must swing through the trigger level to cause a trigger event.

An optional Trigger Timeout value can also be specified to establish the amount of time that the digitizer will wait for a trigger event before the driver forces a trigger event to occur.

Complex triggering makes use of multiple trigger engines and their configurations. Trigger configurations for each logical triggering engine require three specifications: the engine's source, the engine's trigger level, and the engine's trigger conditions. The outputs of each logical triggering engine are Boolean ORed together to create the overall triggering signal. There are two trigger engines for each input channel plus one trigger engine for the external trigger input. Usage of complex triggering allows for Windowed Triggering and Multi-channel Boolean ORed triggering.

Windowed Triggering uses two trigger engines in such a way that a trigger event occurs if the signal voltage leaves a range of voltages specified by an upper limit and a lower limit. Windowed triggering is implemented by selecting the same input channel as the trigger source for two trigger engines.

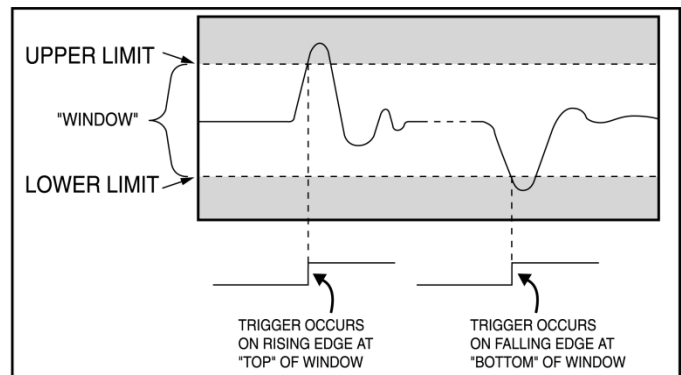

**Figure: Windowed Triggering**

The levels for the two engines are then selected as the upper and lower limit with positive and negative slopes, respectively. In this way, if the signal voltage rises above the upper limit, the first

engine triggers and if the signal voltage falls below the lower limit, the second engine triggers.

Since the outputs of both trigger engines are Boolean ORed together, a trigger on either engine will cause a global trigger event to occur.

### Multiple Record Mode

Multiple Record Mode uses the digitizer onboard memory to allow ultra-rapid repetitive waveform acquisition. In Multiple Record Mode, sequentially acquired waveforms are stacked in onboard memory, so that data transfer to host PC RAM is not required between waveforms.

Furthermore, in Multiple Record Mode, re-arming of trigger circuitry is done in hardware with no software intervention required. The RazorPlus Express features sub-microsecond re-arm times that allow for ultrafast trigger rates in the MHz range.

Pre-trigger data can also be captured in Multiple Record Mode. Memory usage is well optimized in Multiple Record Mode since only the small amount of pre- and post-trigger data containing the pulse of interest are stored to memory. Memory is not wasted in the acquisition of the entire signal between pulses, which is not of interest.

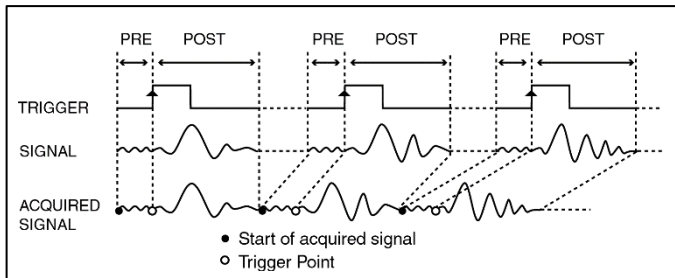

**Figure: Multiple Record Mode with Pre-Trigger Data**

### Timestamping

Timestamping is a feature used to determine the arrival time of waveform trigger events and is most useful when used in Multiple Record Mode. The digitizer has a 44-bit on-board numerical counter. The clock source for the counter may be selected as the digitizer sampling clock or a fixed on-board clock source. The value of the timestamp counter can be reset to zero at the beginning of each acquisition sequence or can be alternatively reset from software at some referenced time.

During an acquisition and upon each trigger event, the current output value of the timestamping counter is latched and is stored in onboard memory as a footer to the current record. After acquisition, the timestamp value associated with each acquired record may be downloaded. When dividing the timestamp value by the known counter source frequency, the occurrence time of each trigger event is obtained.

### PCI Express (PCIe) Generation 3 x8 Interface

The RazorPlus Express utilizes a PCIe Gen3 x8 (8-lane) interface to the host PC and thus requires an open available physical PCIe x8 or larger x16 size slot on the host PC system for installation.

The RazorPlus Express is fully backwards compatible with previous PCIe Gen2 and Gen1 based slots. It is also compatible with newer Gen4 and Gen5 slots but will only operate at its maximum Gen3 rate in these slots.

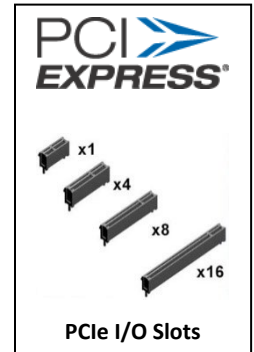

It is possible to operate the RazorPlus Express in PCIe slots that are mechanically x8 or x16 in size but electrically operate at slower x1 or x4 PCIe speeds, though this will reduce the transfer rate speed of the digitizer.

For maximum data transfer rate performance, it is best to install the RazorPlus Express in a dedicated (non-switched) PCIe Gen3, Gen4, or Gen5 slot that electrically operates at x8 or x16 (the card will only operate at its maximum x8 rate). The host system should provide good cooling air flow for the installed RazorPlus Express card location with ideally an empty adjacent slot to prevent blockage of the card's onboard cooling fan.

With the optional eXpert PCIe Data Streaming FPGA Firmware package, acquired data can be streamed to host PC memory via the PCIe Gen3 x8 interface at real-time sustained rates up to 2 GB/s supporting the maximum 500 MS/s sampling rate for both channels for targeted host-based signal processing and/or signal recording operations.

### Device Drivers and Utility Software

The RazorPlus Express is supplied with 64-bit device drivers supporting Windows 11/10 and 64-bit device drivers for Linux distributions of Red Hat and Ubuntu. Note that in general, the user-mode Linux code can be ported to other Linux distribution releases with possible minor modifications to support.

For Linux: Device Drivers, C Application Programming Interface (API), C Software Development Kit (SDK) examples, and a CsTestQt application are included. CsTestQt is a simple Linux GUI application that allows the user to configure the digitizer, conduct displayed capture of signals, and to verify basic correct operation of the digitizer.

For Windows: Device Drivers, a CompuScope Manager Utility application, and a CStest+ Utility application are included.

The CompuScope Manager Utility is used to enable and verify certain hardware configurations of the digitizer and provides details on resource usage, diagnostics, eXpert features, and hardware, software, firmware versioning information.

The CStest+ Utility is a simple application to configure the digitizer, conduct basic capture of signals, and to verify basic correct operation of the digitizer.

### Software Development Kits

GaGe provides extensive software for custom application development with included Software Development Kits (SDKs) for C/C#, Python, MATLAB, and LabVIEW. All SDKs provide several powerful programming examples illustrating the use of the digitizer hardware in different operating modes. These sample programs serve as a starting point for users to develop customized software applications optimized for their specific application requirements.

### CompuScope GPU CUDA Processing

Optionally stream acquired data from the RazorPlus Express to high-performance Graphic Processing Units (GPUs) for signal processing and data recording in real-time!



Utilize high-performance GPU cards to take advantage of the familiar C programming development environment with powerful multi-core parallelized vector processing for real-time signal processing routines on the streamed signal data.

Gage CompuScope C SDK ready-made compiled sample programs illustrate PCIe data streaming to GPU and effective exploitation of GPU parallelized vector processing to attain 10X ~ 100X faster analysis rates than host CPU.

This enables end users to begin quickly and easily working with GPU cards, focusing on the development of their custom in-line processing routines that are unique to their application. Projects can be developed rapidly and are more transportable working in a C programming environment with the GPU CUDA library.

### eXpert FPGA Processing Firmware Options

The default RazorPlus Express configuration can store raw acquired waveform data and transfer it quickly to the user for analysis, display and/or storage.

The addition of optional eXpert FPGA processing firmware features allows for some signal processing analysis to be performed on the digitizer hardware itself within its onboard Field Programmable Gate Array (FPGA).

There are three primary advantages to the processing of waveform data using an eXpert firmware option. First, data can be processed

at full sampling rate speeds, where data rates may exceed what can be sustained for streaming over the PCIe bus to other targeted processing devices. Second, processing data onboard the digitizer hardware reduces the data processing load on the host computer. Third, onboard processing may provide data reduction that reduces the data transfer traffic on the host bus and allow for a greater raw data acquisition rate.

eXpert FPGA feature packages are loaded from an onboard flash memory module and are designed to be transparent to the standard digitizer drivers for Windows/Linux. Only one eXpert FPGA feature can be utilized at a time.

eXpert FPGA feature packages can be purchased at any time and can be implemented on digitizers already in use in the field by existing customers without requiring the digitizer to be returned to GaGe for reprogramming.

GaGe can also develop customized firmware to meet specific customer application requirements. Please contact us with a summarized listing of application requirements to evaluate design feasibility. Pricing for customized FPGA development is highly dependent on the scope of the project work and on expected product volume.

Current eXpert FPGA features available for the RazorPlus include:

eXpert FPGA Option	Feature Description
PCIe Data Streaming	Allows for data streaming mode of acquired data directly through the PCIe interface to the host PC RAM and on to targeted host-based CPU or dedicated processing cards for analysis and/or to high-speed storage systems for real-time signal recordings.
Signal Averaging	Allows for detection of very small repetitive signals in a noisy environment. Using rapid signal averaging, small signals can be extracted from a background of high amplitude noise, which may even be larger than the actual signal itself.

### Multi-Card Systems

Multiple RazorPlus Express cards can work together either within a single system or across multiple systems in two possible configurations: Independent or Synchronized Split.

In an Independent configuration, each card simply operates independently within the system.

In a Synchronized Split configuration, each card operates together as a group by splitting the trigger signal to each card's Trigger In using an RF power splitter (not a BNC Tee) and same equal length cables. This can also be done with the External Clock input if synchronous clocking is required. This mode requires more external hardware but provides the best simultaneity between multiple cards. To further optimize synchronous operations, it is ideal to

have the external trigger source be synchronous with the external clock source using a common 10 MHz external reference clock that is supplied to both the external clock source and the external trigger source.

### Thunderbolt 3 Options

Utilize the RazorPlus Express via the Thunderbolt 3 interface for PC system device form factors with either limited or no PCIe expansion slots such as:



Laptops

2-in-1s

Tablets

All-in-Ones

Mini PCs

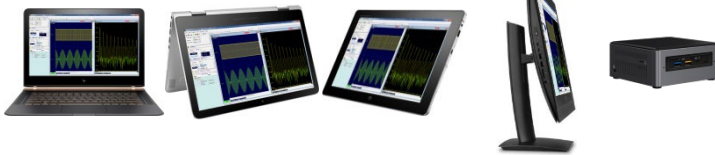

In Thunderbolt 3 mode, up to four lanes of PCIe Gen3 is supported for a maximum rate of 32 Gbps (4 GB/s); making it an ideal match for optimal data transfer performance of the RazorPlus Express PCIe Gen3 Digitizer to connected PC devices.

### Sig-Station System Options



Optional Sig-Stations are available for providing complete turn-key systems for the RazorPlus Express. Sig-Stations are high-performance PC workstations that are designed specifically for integrating GaGe advanced instruments and maximizing their operational performance.

For real-time operations, it is critical that the underlying host platform is fully capable of sustaining high-speed PCIe data streaming rates to and from multiple instruments. Traditional lower cost desktop-based platforms often restrict performance capabilities by placing multiple PCIe slots behind shared PCIe switches. Sig-Station systems utilize dedicated bandwidth PCIe slot architecture for maximum sustained PCIe streaming rates for multiple instruments operating together simultaneously.

Sig-Stations come with all GaGe cards, features, and software fully tested and installed so that the user can be up and running with their system solution right out of the box; thus, saving time and

minimizing risks of self-integrated systems. Custom system configurations can be defined to meet specific customer application requirements.

These systems incorporate the latest in PC-based technology and utilize workstation class motherboards with multiple dedicated bandwidth PCIe slots, high multi-core count Xeon CPUs, and large system memory capacity. Integrated high-speed data storage systems for real-time signal recording applications requiring a guaranteed continuous sustained data streaming rate with no missing data can be included.

Contact us to configure a system tailored for your application.

### GaGeScope – PC Oscilloscope Software

GaGeScope is a solutions-oriented PC oscilloscope software package that allows users to quickly and easily control GaGe's advanced CompuScope digitizers without having to write a single line of code. Data can be displayed, analyzed, printed, and saved with an easy-to-use Windows-based user interface.

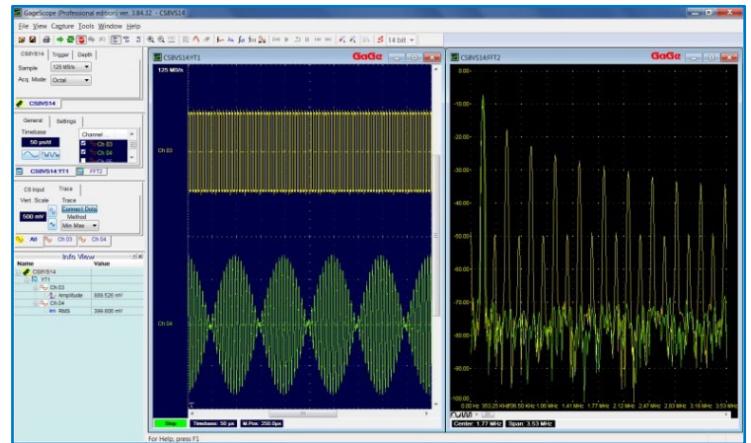

GaGeScope Lite Edition is included and provided free of charge with any CompuScope digitizer model. Optional upgrades to the Standard or Professional Editions of GaGeScope provide access to more advanced features and functionalities that include: Min-Max Decimation, Skip Sample Decimation, Advanced Triggering Control, Left & Right Trigger Alignment, Multiple Independent Triggers, Average/Co-Adding, SuperRes Mode, Multiple Record Mode, Deep Memory Zoom, Cursors with Readings of Amplitude & Time, Engineering Units, Multiple Displays of Same Signal, Dual Cursor with Tracking Mode, Waveform Analysis Parameters, FFT Analysis, Extended Math Channel Function, and more.

### DsScope – IF Signal Recording Software

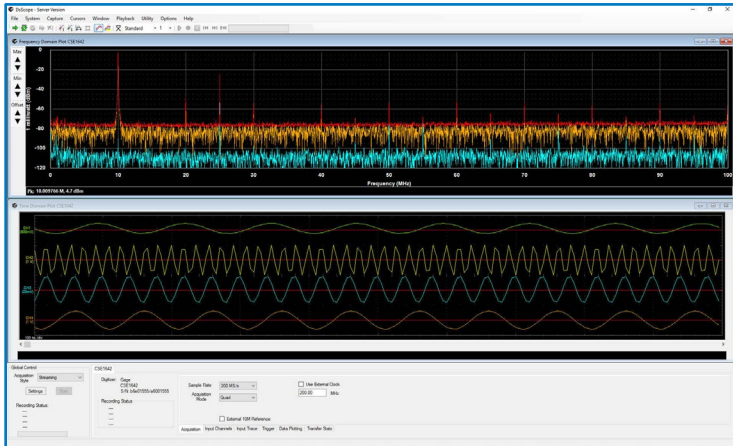

DsScope is a Windows based PC oscilloscope application that requires no programming and allows the operator to view/edit all digitizer hardware settings, display acquired signal data for analysis, and conduct real-time signal recording monitored operations to drive storage. Multiple digitizers are supported.

DsScope provides the ability to save established settings to a configuration file that can be opened and applied, thus saving time from manually re-applying settings for repetitive configurations.

Analysis displays include Time Domain, Frequency Domain, and Spectrogram. Multiple display type windows can be opened and shown simultaneously with auto tile and cascade options or manually sized and placed as desired.

Display windows include support for scope cursors to navigate through the display and obtain measurements. Cursor Track Mode can be enabled to lock the position of the two placed cursors. When locked, the spacing between cursors remains constant as they are moved through the display of data.

The primary advantage of DsScope is the ability to conduct real-time streaming signal recordings to drive storage with provided monitoring capability to ensure the recording process is operating with expected signal data and without errors.

The non-proprietary file format of the raw binary data file allows for other 3rd party software applications to import and utilize the data easily, with associated separate XML-based header files that contain the context information on the data file.

Multiple systems running the DsScope Server option can be accessed and operated as remote nodes with a single user interface over an Ethernet network with the Remote Client option. This is beneficial in cases where multiple systems, that may be dispersed in different locations, need to have acquisition and/or recording operations controlled without physical attendance at each system. A script editor can also be used in conjunction with script execute actions to design an automation sequence for targeted operations.

### DsScopeView – IF Signal Recording Playback Software

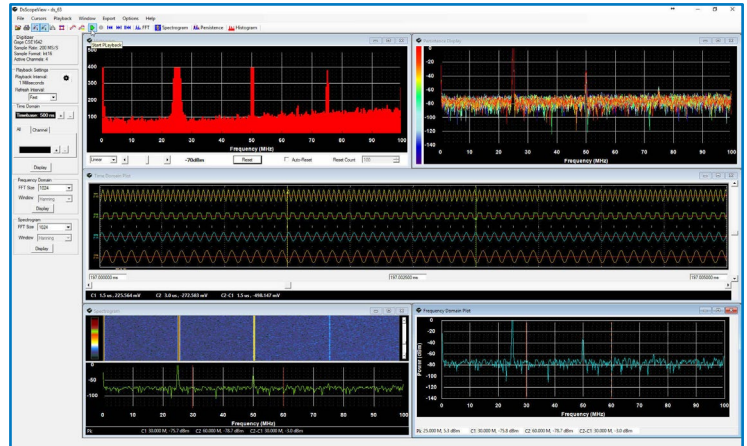

DsScopeView is a Windows based PC oscilloscope application that allows an operator to open/view and conduct playback of previous signal recordings to the display monitor for analysis, with additional display capabilities that include persistence and histogram modes.

Viewing file details will display the details of the opened signal recording present in the header file associated with the recording data file for review. It includes basic information about the recording, applied digitizer model information, and settings utilized for the recording with total elapsed time duration of the recording file.

The various display types for Time Domain, Frequency Domain, Spectrogram, Persistence, and Histogram can all be effectively utilized for playback operations.

Playback operations utilize familiar navigation toolbar buttons for starting playback, stopping playback, stepping backwards and forwards, and moving back to start, and for playback looping when the time domain data will loop from the end of the file back to the beginning when the end of file is reached.

On playback, the processing block size (Playback Interval) and display update rate (Refresh Interval) have flexible adjustment parameters. These allow complete control over the file processing speed and display update rate.

DsScopeView provides an Export Split File feature to facilitate taking a large signal recording file and splitting it into smaller sized files for ease of manipulation and management. This feature is especially useful for transferring smaller data file sizes that contain only the data of particular interest for review, rather than the entire original large signal recording file size.

The main recording file can be split into smaller files based on file size, recording duration, samples, or number of split files. Each segmented/split file contains a binary recording file as well as a corresponding header file that defines the content of the split file.

### SpectraScopeRT – RF Signal Recording Software

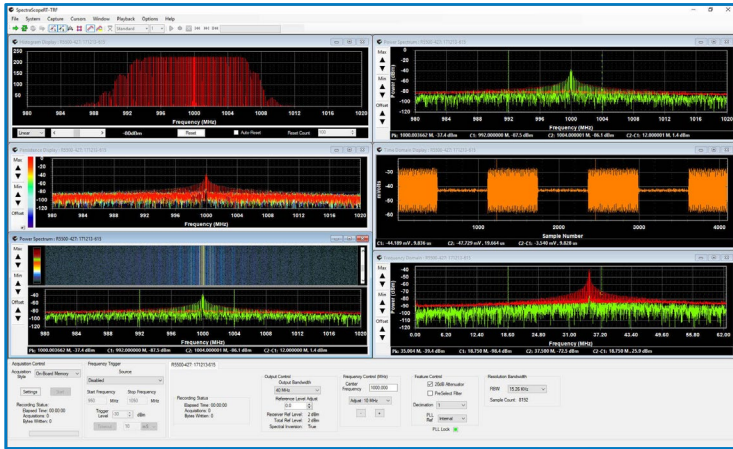

SpectraScopeRT is a Windows based spectrum analyzer application that requires no programming and allows for integrated operational control of both the downconverter receiver and the digitizer for signal capture, analysis, recordings. Any tuner, downconverter, or receiver with an IF output or a virtual receiver is supported.

SpectraScopeRT provides the ability to save established settings to a configuration file that can be opened and applied, thus saving time from manually re-applying settings for repetitive configurations.

Analysis displays include Time Domain, Frequency Spectrum, Power Spectrum, Constellation, Spectrogram, Persistence, and Histogram. Multiple display type windows can be opened and shown simultaneously with auto tile and cascade options or manually sized and placed as desired.

Display windows include support for scope cursors to navigate through the display and obtain measurements. Cursor Track Mode can be enabled to lock the position of the two placed cursors. When locked, the spacing between cursors remains constant as they are moved through the display of data.

The primary advantage of SpectraScopeRT is the ability to conduct real-time streaming signal recordings to drive storage with provided monitoring capability to ensure the recording process is operating with expected signal data and without errors.

The non-proprietary file format of the raw binary data file allows for other 3rd party software applications to import and utilize the data easily, with associated separate XML-based header files that contain the context information on the data file.

Multiple systems running the SpectraScopeRT Server option can be accessed and operated as remote nodes with a single user interface over an Ethernet network with the Remote Client option. This is beneficial in cases where multiple systems, that may be dispersed in different locations, need to have acquisition and/or recording operations controlled without physical attendance at each system. A script editor can also be used in conjunction with script execute actions to design an automation sequence for targeted operations.

### SpectraViewRT – RF Signal Recording Playback Software

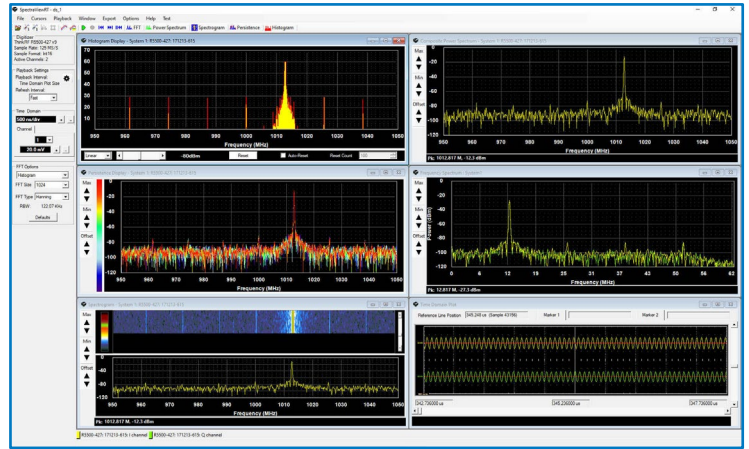

SpectraViewRT is a Windows based application that allows an operator to open/view and conduct playback of previous signal recordings to the display monitor for analysis.

Viewing file details will display the details of the opened signal recording present in the header file associated with the recording data file for review. It includes basic information about the recording, applied digitizer model information, applied receiver model information, and settings utilized for the recording with total elapsed time duration of the recording file.

The various display types for Time Domain, Frequency Domain, Spectrogram, Persistence, and Histogram can all be effectively utilized for playback operations.

Playback operations utilize familiar navigation toolbar buttons for starting playback, stopping playback, stepping backwards and forwards, and moving back to start, and for playback looping when the time domain data will loop from the end of the file back to the beginning when the end of file is reached.

SpectraViewRT provides an Export Split File feature to facilitate taking a large signal recording file and splitting it into smaller sized files for ease of manipulation and management. This feature is especially useful for transferring smaller data file sizes that contain only the data of particular interest for review, rather than the entire original large signal recording file size.

The main recording file can be split into smaller files based on file size, recording duration, samples, or number of split files. Each segmented/split file contains a binary recording file as well as a corresponding header file that defines the content of the split file.



### Wideband RF Signal Analyzer Recorders

Today's high-band signal standards are using higher frequencies and wider bandwidths than ever before for applications such as next generation 5G wireless services, satellite communications, electronic warfare, and more.

The RazorPlus can be combined with wideband downconverters and PC solutions to be the heart of a wideband, multi-channel, RF/Microwave signal analysis and recording system covering signal frequencies up to 27 GHz with 160 MHz bandwidth.

GaGe A-27-Series wideband receivers feature two RF frequency ranges from 9 kHz to 8 GHz or 27 GHz with two optional bandwidth configurations that each supply three software selectable bandwidth modes: Zero IF (ZIF), Super-Heterodyne (SH), or Super-Heterodyne Narrow (SHN):

Bandwidth Mode	Option 1 Bandwidth	Option 2 Bandwidth
ZIF (Zero IF)	100 MHz @ 0 Hz IF	160 MHz @ 0 Hz IF
SH (Super-Heterodyne)	40 MHz @ 35 MHz IF	80 MHz @ 55 MHz IF
SHN (Super-Heterodyne Narrow)	10 MHz @ 35 MHz IF	10 MHz @ 35 MHz IF

The 2 channel RazorPlus Express model can support 1 receiver in baseband ZIF mode (IQ outputs) or 2 receivers in superhet modes (IF outputs). 10 MHz reference inputs and outputs on both the digitizers and receivers provide a single frequency reference for synchronized system performance.

With eXpert PCIe Data Streaming firmware, the large onboard FIFO memory of the RazorPlus Digitizer allows for real-time streaming of I and Q baseband signals via PCI Express (PCIe) to the controller's memory for post processing, display, and storage.

The spectrum analyzer software, SpectraScopeRT, requires no programming and allows for integrated operational control of both the downconverter receiver and the digitizer for signal capture, analysis, and signal recordings.

Complete integrated turnkey systems are available in ultra-portable, portable, desktop and rackmount form factors with scalable storage solutions up to 368 TB for hours of high-speed real-time signal recordings. As COTS-based open architecture systems, component items are also future upgradeable and compatible with other 3rd party items and software.

Contact us to configure a custom system tailored for your application requirements.

### RF Wideband Signal Analyzer Recording System

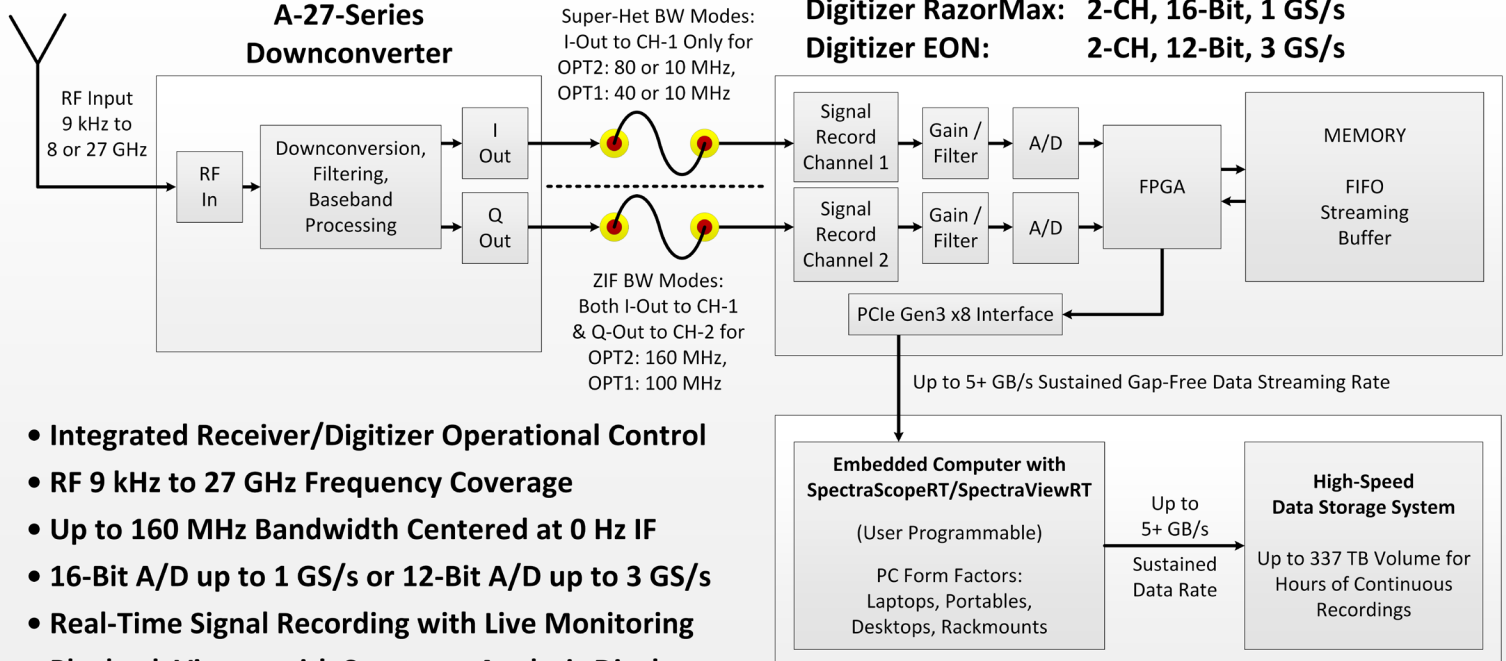

- Integrated Receiver/Digitizer Operational Control
- RF 9 kHz to 27 GHz Frequency Coverage
- Up to 160 MHz Bandwidth Centered at 0 Hz IF
- 16-Bit A/D up to 1 GS/s or 12-Bit A/D up to 3 GS/s
- Real-Time Signal Recording with Live Monitoring
- Playback Viewer with Spectrum Analysis Displays

## RazorPlus Specifications

### Model Specifications

Model #	CSE50216	CSE50214
Vertical Resolution	16-bit	14-bit
# of Input Channels	2 (50 Ω & 1M Ω Pairs)	2 (50 Ω & 1M Ω Pairs)
Max. Rate per Channel	500 MS/s	500 MS/s

### Analog Input Channels

Connectors	SMA Jack (Female)
Impedance	2 x 50 Ω Inputs 2 x 1M Ω Inputs
Coupling	DC (standard) or AC (hardware factory option)
Bandwidth – 50 Ω – DC	DC to 250 MHz
Bandwidth – 50 Ω – AC	200 kHz to 250 MHz
Bandwidth – 1M Ω – DC	DC to 150 MHz
Bandwidth – 1M Ω – AC	10 Hz to 150 MHz
6 x Voltage Ranges (Software selectable)	±100 mV, ±200 mV, ±500 mV, ±1 V, ±2 V, ±5 V
Flatness @ 500 MS/s	Within ±0.5 dB of Ideal Response to 250 MHz
DC User Offset (Software selectable)	Spans Full Scale Input Range (FSIR)
Absolute Max. Input	±10 V (over-voltage protection included)

### A/D Sampling

30 x Software Selectable Rates per Channel	500 MS/s, 425 MS/s, 400 MS/s, 375 MS/s, 365 MS/s, 300 MS/s, 260 MS/s, 250 MS/s, 200 MS/s, 185 MS/s, 160 MS/s, 150 MS/s, 125 MS/s, 100 MS/s, 75 MS/s, 50 MS/s, 25 MS/s, 10 MS/s, 5 MS/s, 2 MS/s, 1 MS/s, 500 kS/s, 200 kS/s, 100 kS/s, 50 kS/s, 20 kS/s, 10 kS/s, 5 kS/s, 2 kS/s, 1 kS/s
Rate Accuracy	±1 part-per-million (0° to 50° C ambient)

### Acquisition Memory

Acquisition memory size is shared and equally divided among all active input channels (2 or 1).	
Standard Size	4 GS (8 GB)
Architecture	Dual Port
Data Streaming Support	Yes

### Performance

±500 mV, DC Coupled, 50 Ω, Sampling Rate 500 MS/s		
Resolution	16-bit	14-bit
Signal Frequency	10 MHz	10 MHz
ENOB	11.8 Bits	11.3 Bits
SNR	74 dB	71 dB
THD	-79 dB	-76 dB
SINAD	73 dB	70 dB
SFDR	86 dB	84 dB

RMS Noise	~0.7 mV RMS
-----------	-------------

### Triggering

Engines	2 per Channel, 1 for External Trigger
Source	Any Input Channel, External Trigger, Software
Input Combination	All Combinations of Sources Logically OR'ed
Slope (Software selectable)	Positive or Negative
Sensitivity	±2% of Full-Scale Input Range of Trigger Source. Signal amplitude must be at least 4% of full scale to cause a trigger to occur. Smaller signals are rejected as noise.
Post-Trigger Data	32 points minimum. Can be defined with 32-point resolution.
Pre-Trigger Data	Up to 128 kS Total

### External Trigger

Connector	SMA Jack (Female)
Impedance	2k Ω
Coupling	DC
Bandwidth	>100 MHz
Voltage Range	0 – 3 V

### Trigger Out

Connector	SMA Jack (Female)
Impedance	50 Ω
Amplitude	0 – 1.8 V

### Clock In

Connector	SMA Jack (Female)
Impedance	50 Ω
Coupling	AC
Signal Level	Minimum 1 V RMS, Maximum 2 V RMS
Duty Cycle	50% ±5%
Input Modes	External Clock or 10 MHz Reference Clock
External Clock Mode Input	Minimum 500 MHz to Maximum 1 GHz. External clock frequency input must be twice the targeted A/D sampling rate frequency of 250 MHz (250 MS/s) to 500 MHz (500 MS/s).
External Reference Clock Mode Input	10 MHz ±1000 ppm; the external reference time base is used to synchronize the internal sampling clock.

## Clock Out

Connector	SMA Jack (Female)
Impedance	50 Ω
Signal Level	±750 mV
Duty Cycle	50% ±10%
Output Modes	Maximum Sampling Clock Frequency or 10 MHz Reference Clock
Max. Frequency	500 MHz
Min. Frequency	250 MHz
10 MHz Ref. Clock Mode Rate	10 MHz from Internal Reference

## Timestamping

Timing Resolution	One Sample Clock Cycle
Counter Rollover	>48 Hours Continuous
Multiple Record Mode Segment Timestamp Tail Size	Dual Channel Mode: 64 bytes or 32 samples Single Channel Mode: 128 bytes or 64 samples

## Multi-Card Operational Modes

Independent	Each card operates independently within the system.
Synchronized Split	Each card operates together as a group by splitting the trigger signal to each card's Trigger In using an RF power splitter (not a BNC Tee) and same equal length model cables. This can also be done with the External Clock input if synchronous clocking is required. This mode requires more external hardware but provides the best simultaneity between multiple cards. To further optimize synchronous operations, it is ideal to have the external trigger source be synchronous with the external clock source using a common 10 MHz external reference clock that is supplied to both the external clock source and the external trigger source.

## Dimensions

Size	Single Slot PCIe, Full Height, 6.7 in (170.18 mm) Length
------	--

## Power

Power Operating	25 Watts (typical)
Power Source	Host PCIe Slot; no additional power connectors required.

## PC System Requirements

PCI Express (PCIe) Host Slot	1 Free Full-Height PCIe x8 or x16 Gen5, Gen4, Gen3, Gen2, or Gen1 Slot.
PC Host System Cooling	Provide good cooling air flow for installed RazorPlus Express location with ideally an empty adjacent slot to prevent blockage of card's onboard cooling fan.
PC Operating System	Windows 11/10 (64-bit), Linux Red Had or Ubuntu (64-bit) * *Note: In general, the user-mode Linux code can be ported to other Linux distribution releases with possible minor modifications to support.



By **VITREK**

# RazorPlus Express Digitizer

16-Bit / 14-Bit, 2-CHs @ 500 MS/s, PCIe Gen3 x8

## GaGe Sales

Phone : (815) 838-0005  
Email : [sales-gage@vitrek.com](mailto:sales-gage@vitrek.com)

To find your local sales representative or distributor visit:

<https://vitrek.com/sales-network>

GaGe is a product brand of Vitrek, a USA fully accredited ISO 9001:2015 quality certified and ISO 17025 calibration certified company.



## Corporate Headquarters

Vitrek, LLC  
12169 Kirkham Rd.  
Poway, CA 92064  
USA

## Office Locations

900 N. State St.  
Lockport, IL 60441  
USA

325 Washington Ave Extension  
Albany, NY 12205  
USA

1 Provost, Suite 200  
Lachine, QC, H8S 4H2  
Canada

## Warranty

Standard two years parts and labor.

Unless otherwise specified, all dynamic performance specifications have been qualified on engineering samples. All specifications are subject to change without notice.

Datasheet Revision 3 – 08/25/2023

Copyright © 2022 Vitrek, LLC  
All rights reserved.

## ORDERING INFORMATION

Model #	A/D Resolution	# of Input Channels	Max. Sampling Rate per Channel	Max. Input Bandwidth	Onboard Memory Size	Order Part #
CSE50216	16-bit	2 (50Ω & 1MΩ Pairs)	500 MS/s	250 MHz	4 GS (8 GB)	RZP-502-016
CSE50214	14-bit	2 (50Ω & 1MΩ Pairs)	500 MS/s	250 MHz	4 GS (8 GB)	RZP-502-014

### Front-End Option

AC-Coupled Front-End Option (Hardware configured at factory.)	RZP-FAC-001
---	-------------

### eXpert FPGA Firmware Options

eXpert PCIe Data Streaming	STR-181-000
eXpert PCIe Signal Averaging	250-181-001

### Cable Accessories

Set of 1 Cable SMA Plug (Male) to BNC Plug (Male), 36 Inches (914.4 mm) Length	ACC-001-031
Set of 4 Cables SMA Plug (Male) to BNC Plug (Male), 36 Inches (914.4 mm) Length	ACC-001-033

### Software Development Kits (SDKs)

CompuScope SDKs for C/C#, Python, MATLAB, & LabVIEW are all included	Included
--	----------

### GPU CUDA Processing

Requires eXpert PCIe Data Streaming Firmware (STR-181-000) for Digitizer Card, GPU CUDA Examples in CompuScope SDK for C/C# NOTE: GPU Card NOT Included.	Order STR-181-000 for Digitizer Card
---	--------------------------------------

### GaGeScope – PC Oscilloscope Software

GaGeScope Lite Edition	Included
GaGeScope Standard Edition with Purchase of Hardware	300-100-351
GaGeScope Standard Edition Purchased Independently	300-100-352
GaGeScope Professional Edition with Purchase of Hardware	300-100-354
GaGeScope Professional Edition Purchased Independently	300-100-355

### DsScope – IF Signal Recording & Playback Viewer Software

DsScope Standard Edition: Single Local Host Operation	DSD-DSS-A00
DsScope Server Edition: Single Server Host Operation	DSD-DSS-B00
DsScope Remote Client Edition: Single Remote Client Operation	DSD-DSS-C00
DsScopeView: Single Local Host Operation	DSD-DSV-000

### SpectraScopeRT – RF Signal Recording & Playback Viewer Software

SpectraScopeRT Standard Edition: Single Local Host Operation	DSD-SRT-A00
SpectraScopeRT Server Edition: Single Server Host Operation	DSD-SRT-B00
SpectraScopeRT Remote Client Edition: Single Remote Client Operation	DSD-SRT-C00
SpectraViewRT: Single Local Host Operation	DSD-SVT-000