

Model 3514
16-channel, Scanning A/D Converters

INSTRUCTION MANUAL

February, 1990

(C) 1990
Copyright by
KineticSystems Corporation
Lockport, Illinois
All rights reserved

*** SPECIAL OPTION ***

Model 3514-S002

16-channel, Scanning A/D Converters

July, 1989

(C) 1977, 1981, 1982, 1987, 1989
Copyright by
KineticSystems Corporation
Lockport, Illinois
All rights reserved

Model 3514-S002

***** Special Option *****

The module 3514-S002 is the same as the module 3514-A1A except that the 16-channel ADC Multiplexer is strapped and calibrated for ± 10 volt range.

MLH:rem(WP\MLH)
July 26, 1989

*****Special Option*****

Model 3514-S003

16-channel, Scanning A/D Converters

October, 1992

**(C) 1992
Copyright by
KineticSystems Corporation
Lockport, Illinois
All rights reserved**

Page 1S of 2S

Model 3514-S003

*****Special Option*****

Model 3514-S003

The Model 3514-S003 is the same as the Model 3514-P1A except that it is strapped and calibrated for ± 5 volt operation.

PLM:rem
October 28, 1992

CONTENTS

Features and Applications	1
General Description	1
Feature Comparison	1
Front Panel	1
Monitoring 4-20 mA Signals	1
Function Codes	2
Block Diagram	2
Power Requirements & Ordering Information	2
Instrumentation Amplifier Settling Time Selection	
Strap Selection	4
Input Range Strap Selection	5
Calibration	11
Instrumentation Amplifier Offset Adjustment	13
Instrumentation Amplifier MN2200 Data Sheet 14	
AD-ADC80 Data Sheet	20
Burr Brown SHC85 Data Sheet	28
Burr Brown MPC8D Data Sheet	32
Socket/Wire List for 3514-A1A 39	
Pin/Wire List for 3514-E1A	40
Pin/Wire List for 3514-P1A	41
Warranty	42
Schematic Drawing #022126-D-1857	See Reply Card

KineticSystems Corporation

Standardized Data Acquisition and Control Systems

3512,14

16-channel, Scanning A/D Converters

©1977, 1987, 1989
(Rev. Feb. 89)

FEATURES

- Differential inputs
- 16 channels
- Self-scanning
- Internal buffer memory
- 12-bit resolution (1 part in 4096)
- Protected for 300 volt transient (3512)

APPLICATIONS

- Temperature measurement
- Pressure measurement
- 4-20 mA loop-control signal sensing
- Potentiometer position sensing
- Power supply voltage sensing

GENERAL DESCRIPTION

The Models 3512 and 3514 are single-width CAMAC modules for converting 16 analog voltages into equivalent digital values which can be read via the Dataway. The inputs are continuously scanned and converted, and the results stored in the module's 16-word memory. Thus, the CAMAC read cycles are asynchronous with the conversion process, eliminating any overhead due to testing for converter busy. The analog voltages are converted using a sample-and-hold amplifier and a successive-approximation converter.

The 3514 contains many attractive features, making it desirable for most applications. The 3512 provides high transient voltage protection and contains optional input filters; it is useful in very high noise environments.

FEATURE COMPARISON

Item	3512	3514
Input protection	± 35V steady state ± 300V for 100 μ s	± 35V steady state
Operating common-mode voltage	± 12V max	± 12V max
Input voltage ranges	2.5V to 10V unipolar and bipolar	2.5 mV to 10V unipolar and bipolar
Input filters	optional	not available
Scan rate (16 channels)	16 ms	1040 μ s to 512 ms
Disable scan (Write/Read single channel)	No	Yes
Resolution	12 bits	12 bits
Input Impedance	10 ⁹ Ω	10 ⁸ Ω

FRONT PANEL

The N-light flashes when the module is addressed. The ACTIVE light is on whenever the module is powered and scanning is activated.

MONITORING 4-20 MILLIAMPERE SIGNALS

For monitoring 4-20 milliamper analog signals, it is standard practice to mount a precision 250 ohm resistor external to the module (at the terminal strip) and use the 0 to 5 volt input range. This allows input to the 3512 to be disconnected without disrupting the current loop. The loop must not exceed the maximum operating common-mode voltage rating of the module.



FUNCTION CODES

Command (see Note 1)	Q	Action
F(0)·A(i) RD1	1	Reads Data register (i). (See Note 2.)
F(16)·A(0) WT1	1	Writes Channel number.
F(24)·A(0) DIS	1	Disables the automatic Scan-and-clear Channel Address register.
F(26)·A(0) ENB	1	Enables the automatic Scan.
Z CZ	0	Enables the automatic Scan-and-restart sequence controller.

Notes: 1. Only the F(0)·A(i) and Z commands are valid for the 3512.
 2. Subaddress (i) ranges from 0 to 15 for Channels 0 to 15, respectively.
 3. X = 1 for all valid addressed commands.

BLOCK DIAGRAM (3514 single-channel control not shown)

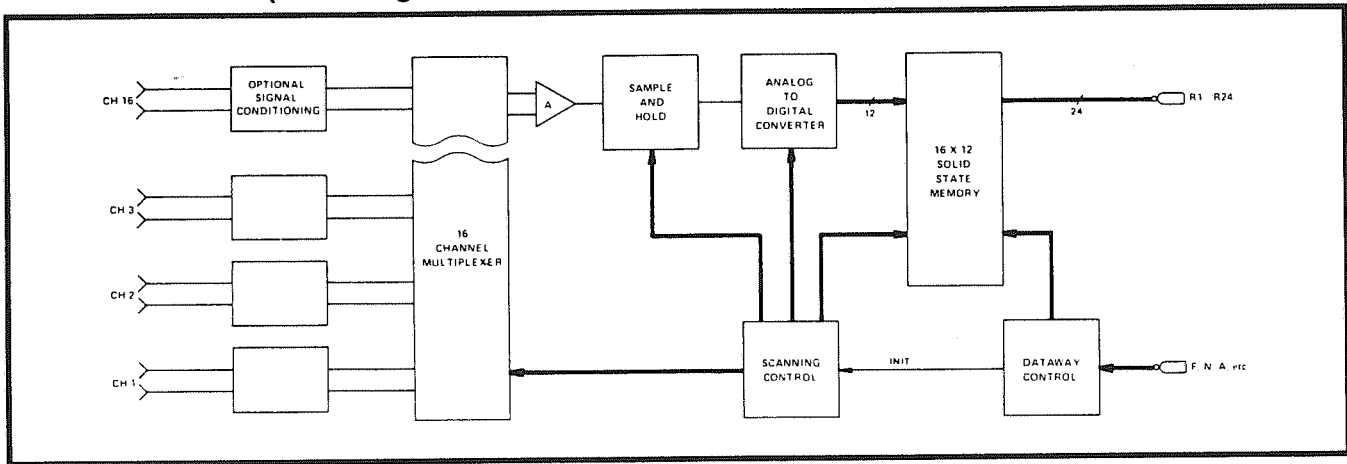

POWER REQUIREMENTS

Model	+ 6 volts	+ 24 volts	- 24 volts
3512	600 mA	65 mA	30 mA
3514	850 mA	50 mA	60 mA

ORDERING INFORMATION (including Accessories)

Weight: .75 kg. (1 lb. 11 oz.)

Model	Filter	I/O Connector	Mating Connector	Termination Panel (see Note)
3512-A1A	10 Hz/3dB	50-contact Ribbon-socket	5950-Z1A	1850-A1D/1854-A2A
3512-A1B	None	50-contact Ribbon-socket	5950-Z1A	1850-A1D/1854-A2A
3512-E1A	10 Hz/3dB	50-pin "D" Plug	5934-Z1A	1850-E1D
3512-E1B	None	50-pin "D" Plug	5934-Z1A	1850-E1D
3514-A1A	None	50-contact Ribbon-socket	5950-Z1A	1850-A1D/1854-A2A
3514-E1A	None	50-pin "D" Plug	5934-Z1A	1850-E1D
3514-P1A	None	36-contact P.C. (rear)	5960-Z1A or Z1B	1850-P1D

Note: The 1854-A2A Rack Termination Panel provides terminations for two 3512 or 3514 modules on a single panel. Order one 1854-A2A and two each 5853-E30J Module I/O Cables (for 50-contact ribbon connector options only).

INSTRUMENTATION AMPLIFIER SETTLING TIME SELECTION

Amplifier settling time required depends on several parameters, including the instrumentation amplifiers gain selection, and the Analog-to-Digital converter range setting. Combinations of a delay period (T) strap selection and delay period multiplier switch setting (see Figure 1) allow for user-selectable settling times ranging from 20 microseconds to 32 milliseconds.

The settling time delay is determined by:

$$\text{Delay} = T * (1 + \text{Switch Setting})$$

Where T is the Delay clock period strap setting, and Switch Setting is the decimal value set into the multiplier switch.

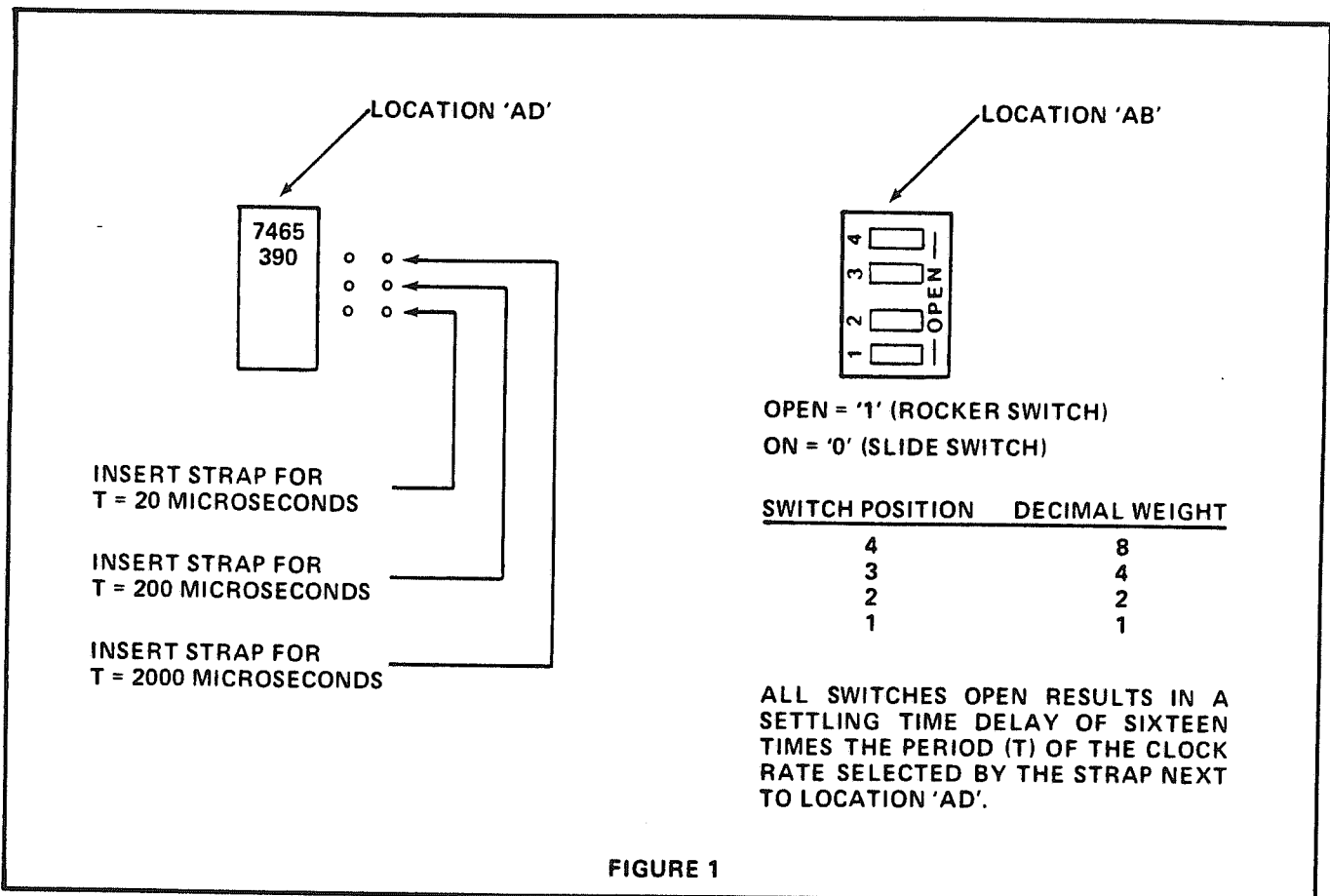

A reasonable "standard" setting for delay is 60 microseconds (strapped for a 20 microsecond delay period, and a multiplier switch setting of 2).

GAIN STRAP SELECTION

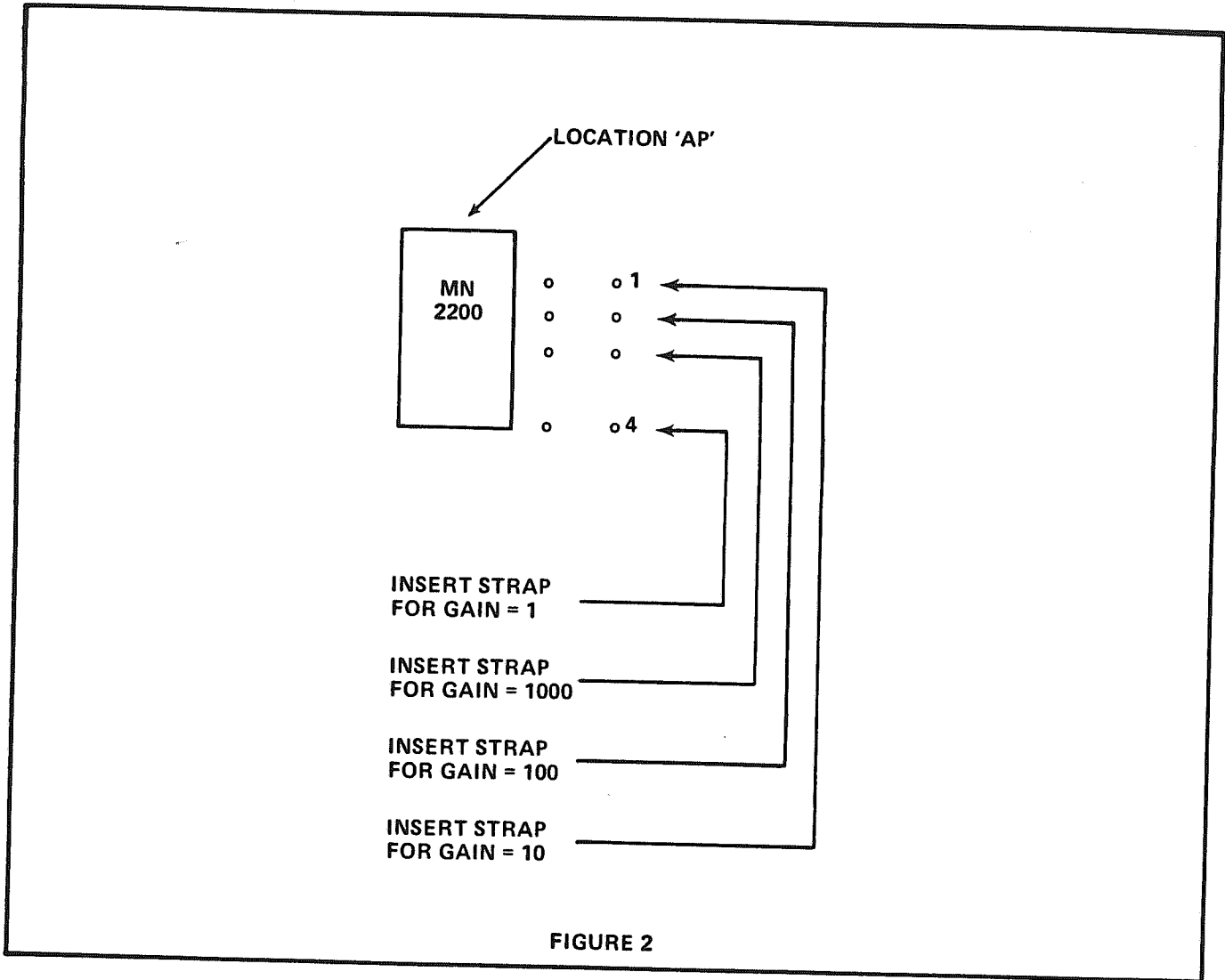

FIGURE 2

This strapping option allows low-level inputs to be scaled up to levels which use as much of the ADC's range as possible. Only one strap should be in place at one time.

Model 3514

INPUT RANGE STRAP SELECTION

The Model 3514's ADC can be operated in any of the following input ranges: 0 to +5V, 0 to +10V, +/- 5V, +/- 2.5V and +/- 10V. Figures 3 - 7 show the strapping for the different ranges.

Note that the "voltage in" referred to in these charts are the input to the ADC. This is only the input to the module if the instrumentation amplifier is strapped for a gain of 1. The voltage at the module input is thus:

$$(\text{module input voltage}) = (\text{"voltage in"})/(\text{strapped gain})$$

INPUT RANGE STRAP SELECTION

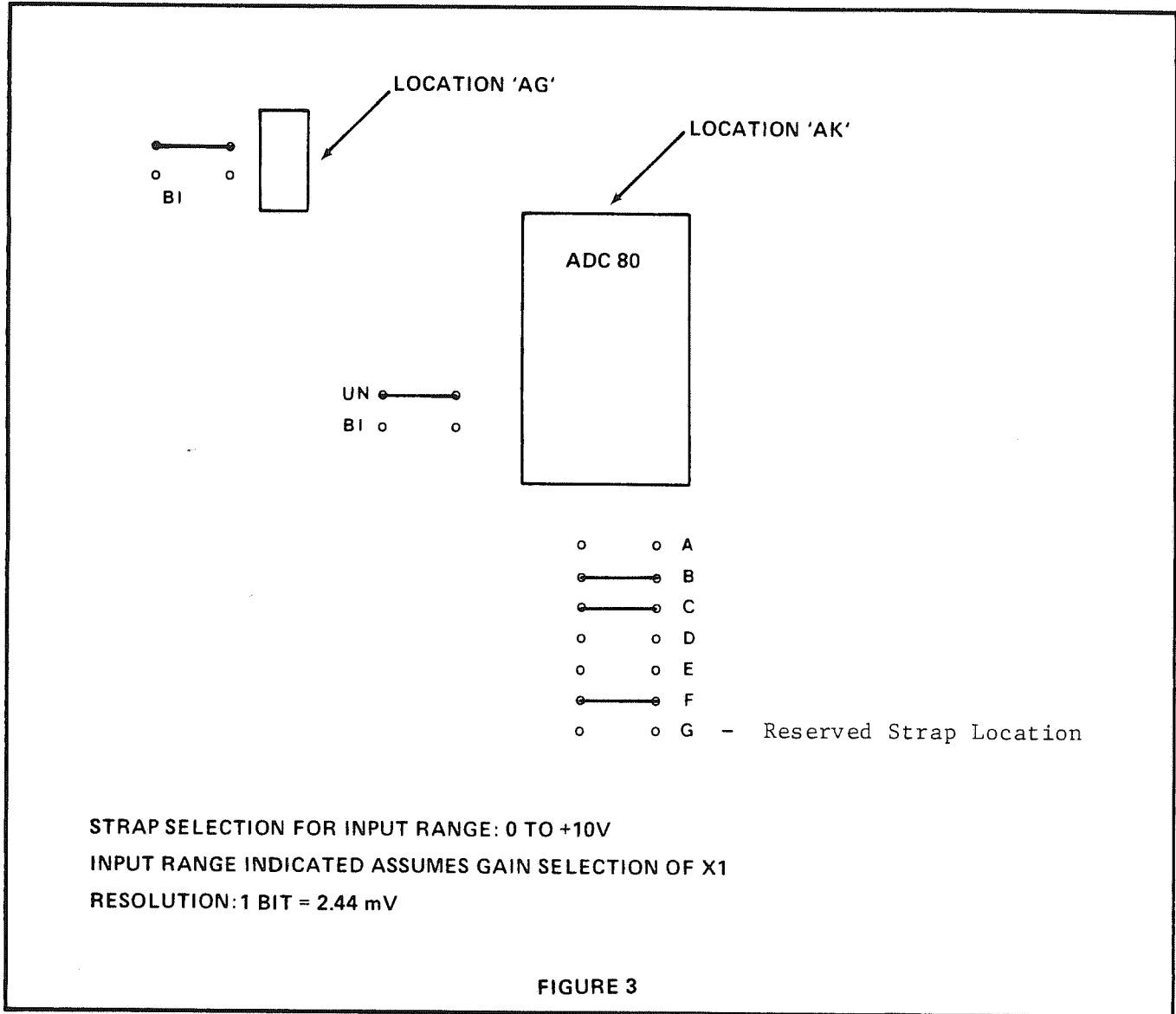

DIGITAL OUTPUT

R24 R13	R12 R9	R8 R5	R4 R1	VOLTAGE IN
0 0	1 1 1 1	1 1 1 1	1 1 1 1	+9.9976V
0 0	1 0 0 0	0 0 0 0	0 0 0 0	+5.000V
0 0	0 0 0 0	0 0 0 0	0 0 0 1	+0.0024V
0 0	0 0 0 0	0 0 0 0	0 0 0 0	0.0V

INPUT RANGE STRAP SELECTION

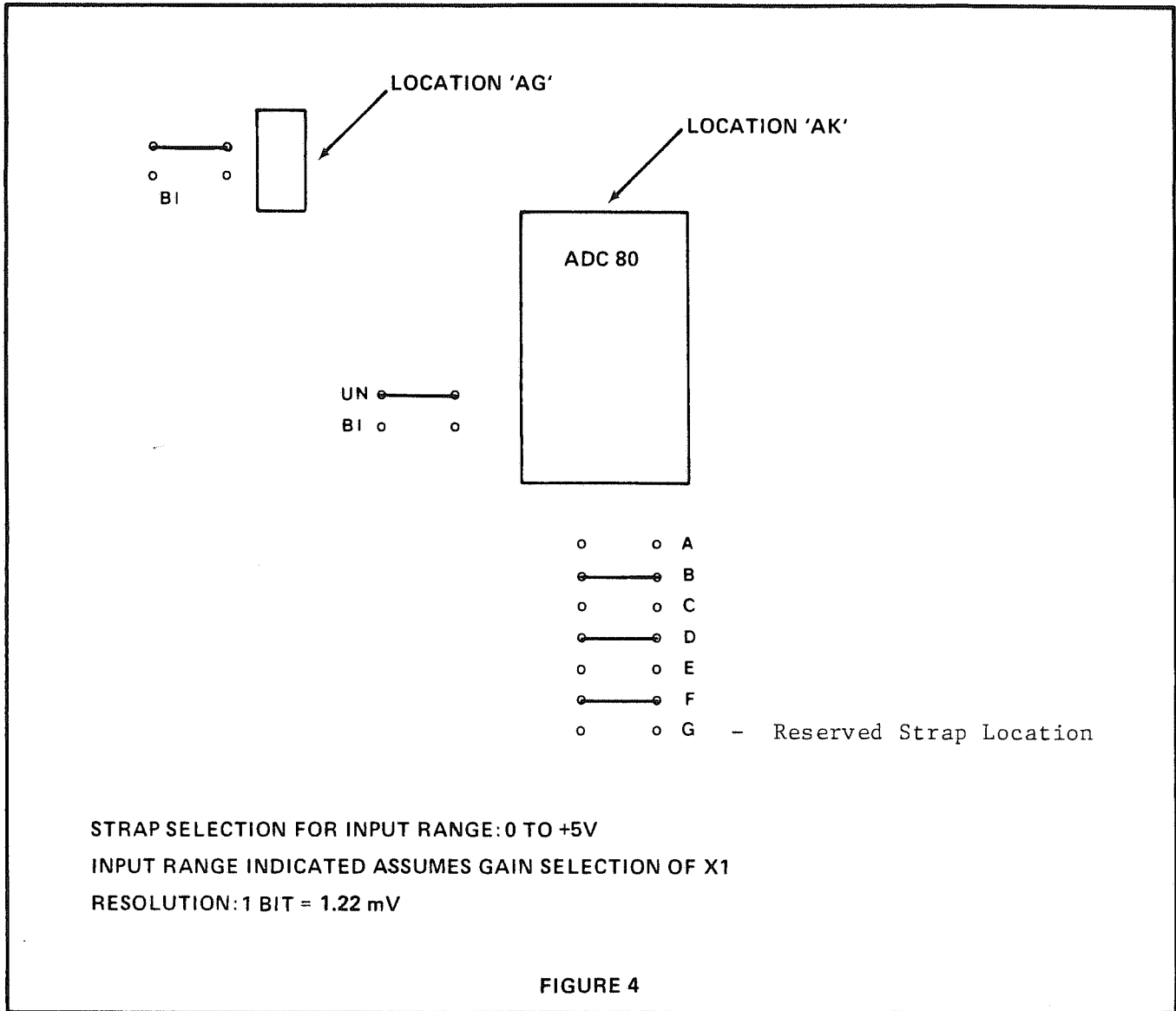

DIGITAL OUTPUT

R24 R13	R12 R9	R8 R5	R4 R1	VOLTAGE IN
0 0	1 1 1 1	1 1 1 1	1 1 1 1	+4.9988V
0 0	1 0 0 0	0 0 0 0	0 0 0 0	+2.5V
0 0	0 0 0 0	0 0 0 0	0 0 0 1	+0.012V
0 0	0 0 0 0	0 0 0 0	0 0 0 0	0.0V

INPUT RANGE STRAP SELECTION

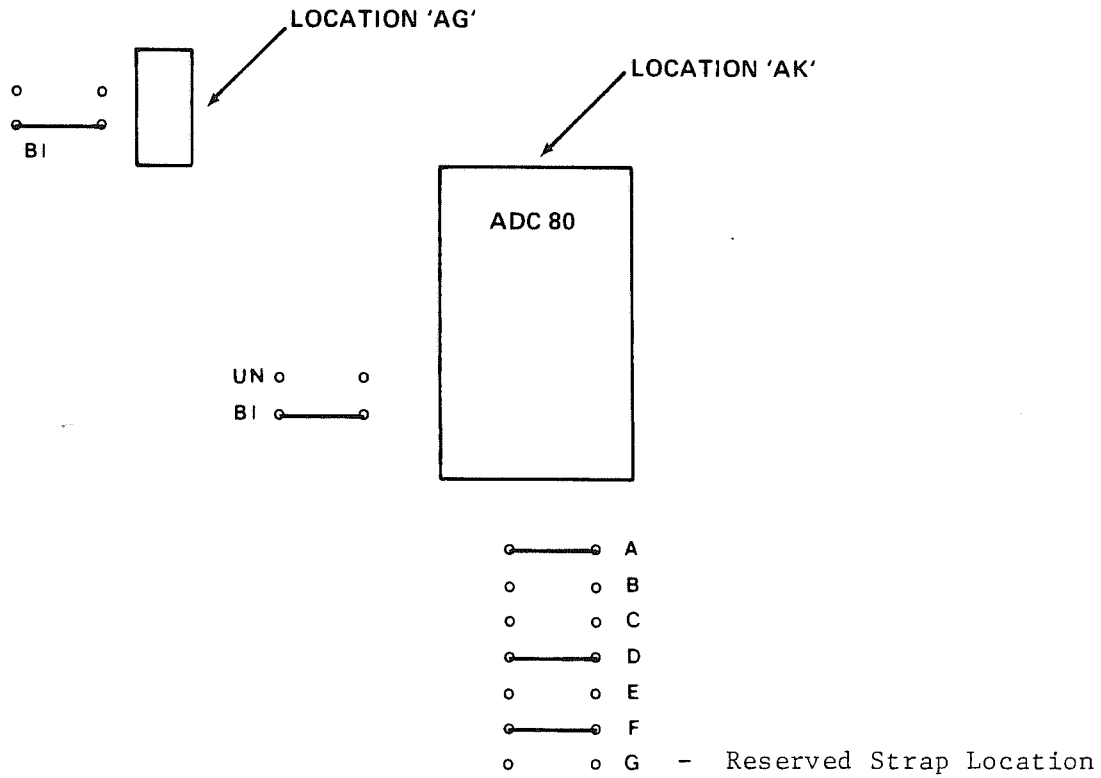

STRAP SELECTION FOR INPUT RANGE: $\pm 2.5V$
 INPUT RANGE INDICATED ASSUMES GAIN SELECTION OF X1
 RESOLUTION: 1 BIT = 1.22 mV

FIGURE 5

DIGITAL OUTPUT

R24 R13	R12 ---- R9	R8 ---- R5	R4 ---- R1	VOLTAGE IN
0 0	0 1 1 1	1 1 1 1	1 1 1 1	+2.4988V
0 0	0 0 0 0	0 0 0 0	0 0 0 0	0.0000V
1 1	1 1 1 1	1 1 1 1	1 1 1 1	-0.0024V
1 1	1 0 0 0	0 0 0 0	0 0 0 1	-2.4988V
1 1	1 0 0 0	0 0 0 0	0 0 0 0	-2.500V

INPUT RANGE STRAP SELECTION

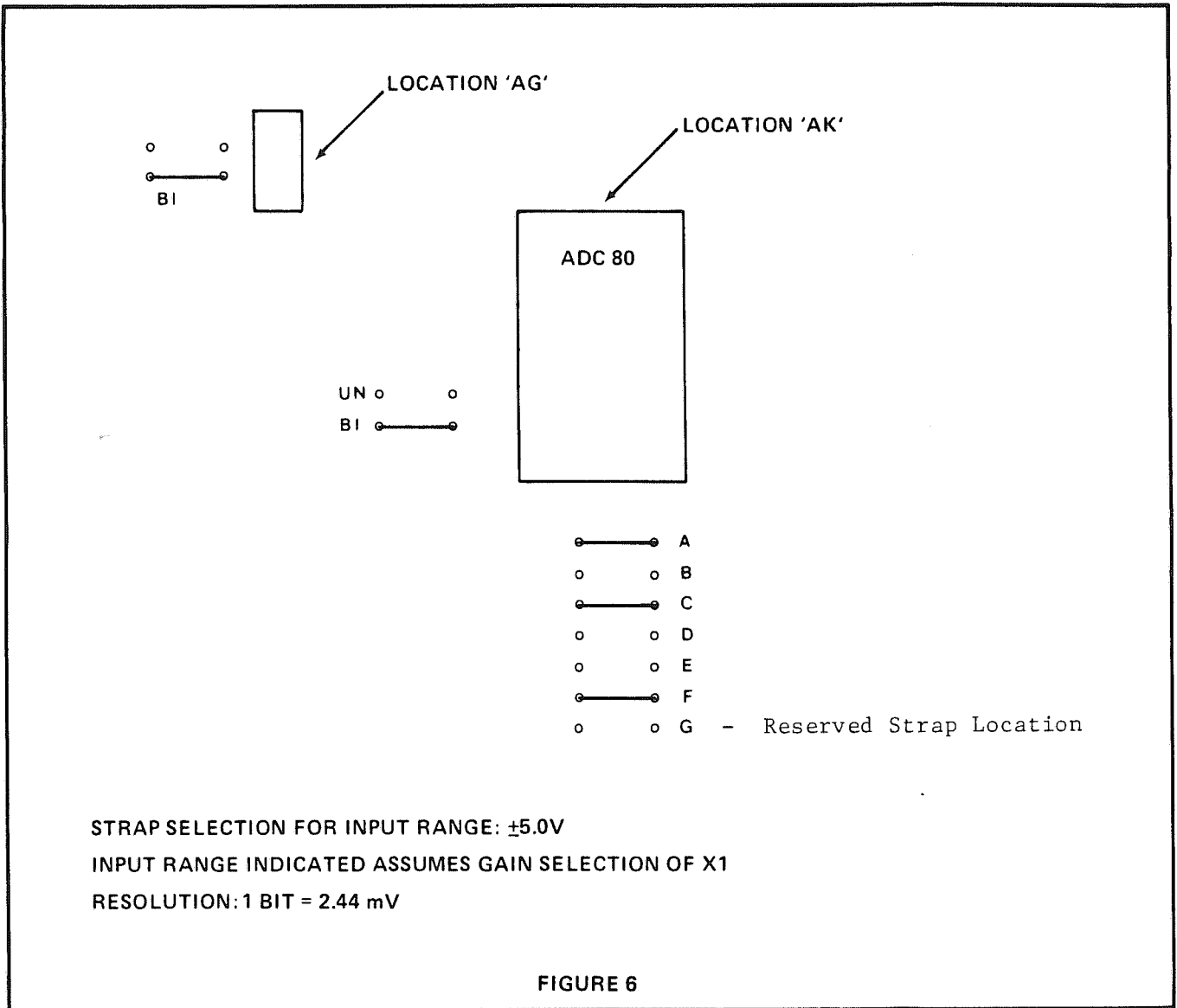

DIGITAL OUTPUT

R24 R13	R12 R9	R8 R5	R4 R1	VOLTAGE IN
0 0	0 1 1 1	1 1 1 1	1 1 1 1	+4.9976V
0 0	0 0 0 0	0 0 0 0	0 0 0 0	0.0000V
1 1	1 1 1 1	1 1 1 1	1 1 1 1	-0.0024V
1 1	1 0 0 0	0 0 0 0	0 0 0 1	-4.9976V
1 1	1 0 0 0	0 0 0 0	0 0 0 0	-5.0000V

INPUT RANGE STRAP SELECTION

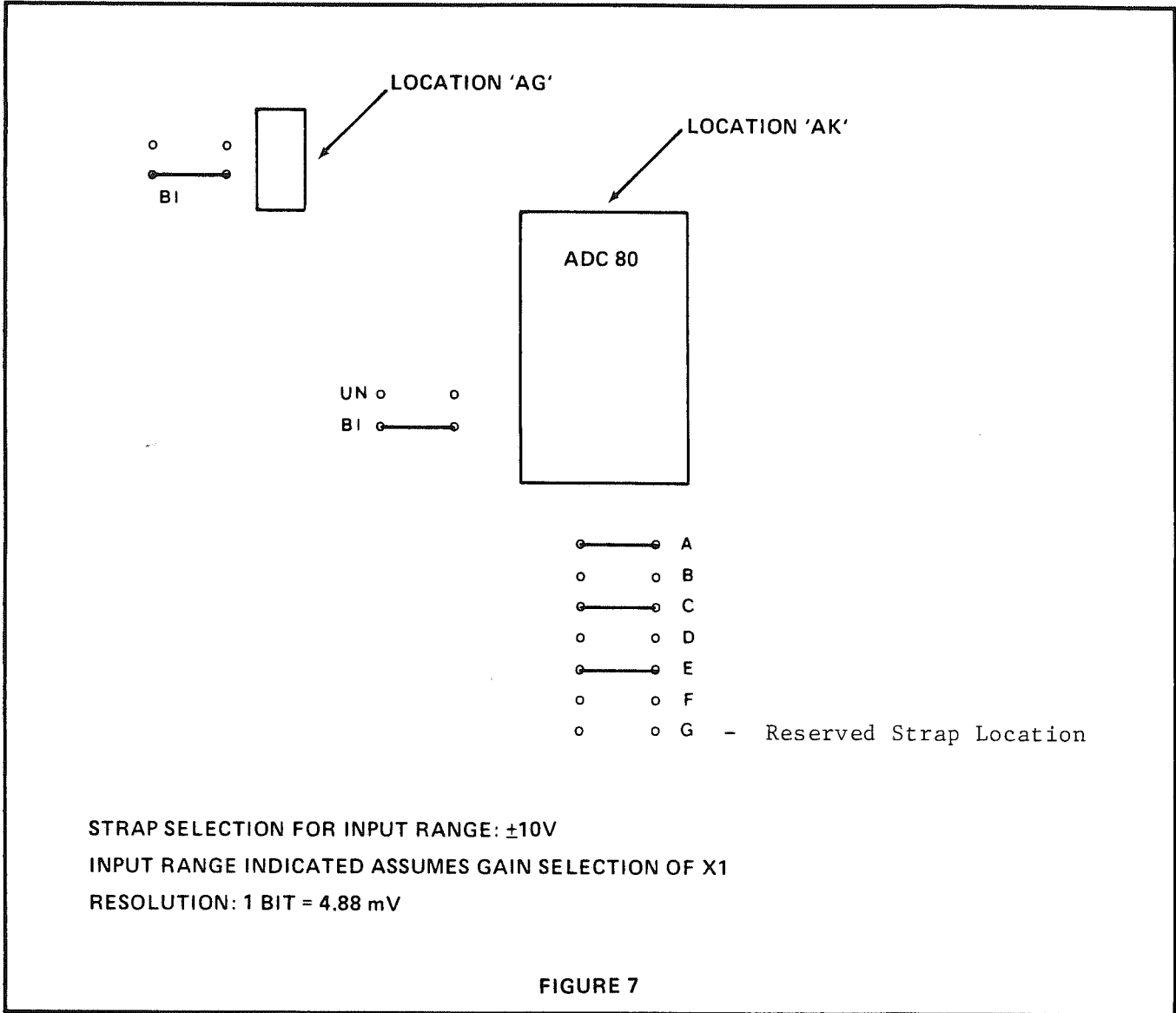

DIGITAL OUTPUT

R24 R13	R12 R9	R8 R5	R4 R1	VOLTAGE IN
0 0	0 1 1 1	1 1 1 1	1 1 1 1	+9.9952V
0 0	0 0 0 0	0 0 0 0	0 0 0 0	0.0000V
1 1	1 1 1 1	1 1 1 1	1 1 1 1	-0.0048V
1 1	1 0 0 0	0 0 0 0	0 0 0 1	-9.9952V
1 1	1 0 0 0	0 0 0 0	0 0 0 0	-10.0V

Model 3514

CALIBRATION

The Model 3514 is factory-strapped and calibrated for a gain of 1 and an input range of 0 to 5 volts. If different gain and/or input range strap selections are made, it is advisable to recalibrate the module to maintain high data accuracy. If, for this or any other reason, it becomes necessary to recalibrate the Model 3514, the following procedure is recommended:

1. Strap the module as it will be used.
2. Disable scanning and select channel 0 with N·F(24)·A(0).
3. Ground the channel 0 input pins (1, 26) in the front-panel connector.
4. Monitor the output of the instrumentation amplifier at chip AP pin 8.
5. Adjust the potentiometer above the instrumentation amplifier until the voltage at the output is 0.000 volts. (See figure 8.)
6. Attach a voltage source to channel 0 of the front-panel connector. The source should be capable of maintaining a clean and stable output with a resolution of at least 1/10 LSB.
7. Set the voltage source to the "LSB on" specified input as shown below.

Input Range	Voltage source setting (Volts)			
	Gain = 1	Gain = 10	Gain = 100	Gain = 1000
0 to +5V	.00122	.00012	.000012	.0000012
0 to +10V	.00244	.00024	.000024	.0000024
+/- 5V	-4.9976	-.49976	-.049976	-.0049976
+/-2.5V	-2.4988	-2.4998	-.024988	-.0024988
+/- 10V	-9.9952	-.99952	-.099952	-.0099952

8. While repeatedly reading channel 0 with N·F(0)·A(0), adjust the ADC offset potentiometer (see figure 9) until the LSB (and bits R24 - R12 for bipolar ranges) is (are) the only bit(s) set. With repeated reads of channel 0, a Dataway Monitor such as the KineticSystems Model 3291 may be used to monitor the data.

Model 3514

9. Set the voltage source to the "LSB off" specified input as shown below.

Input Range	Voltage source setting (Volts)			
	Gain = 1	Gain = 10	Gain = 100	Gain = 1000
0 to +5V	4.99756	.499756	.0499756	.00499756
0 to +10V	9.99512	.999512	.0999512	.00999512
+/- 5V	4.99512	.499512	.0499512	.00499512
+/- 2.5V	2.49756	.249756	.0249756	.00249756
+/- 10V	9.99024	.999024	.0999024	.00999024

10. While repeatedly reading channel 0 with $N \cdot F(0) \cdot A(0)$ (as in step 8), adjust the ADC gain potentiometer (see figure 9) until bits 2 - 12 (2 - 11 for bipolar ranges) are the only bits set.

The Model 3514 is now fully calibrated for the selected ranges.

INSTRUMENTATION AMPLIFIER OFFSET ADJUSTMENT

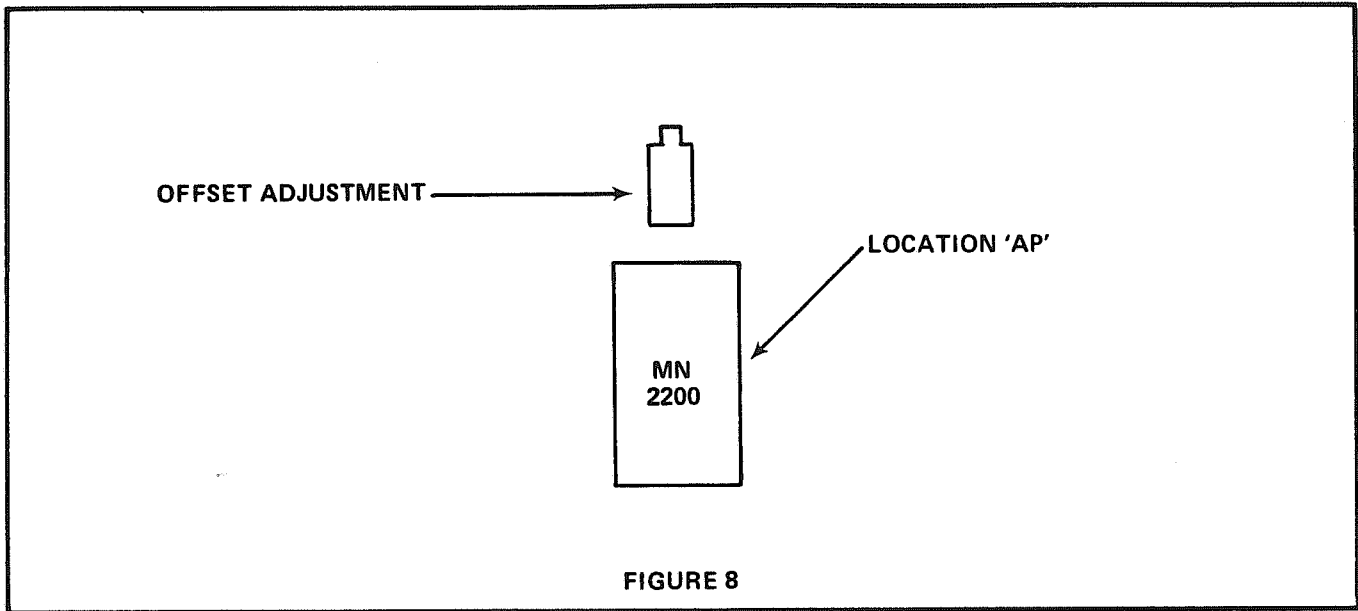

ADC OFFSET AND GAIN ADJUSTMENTS

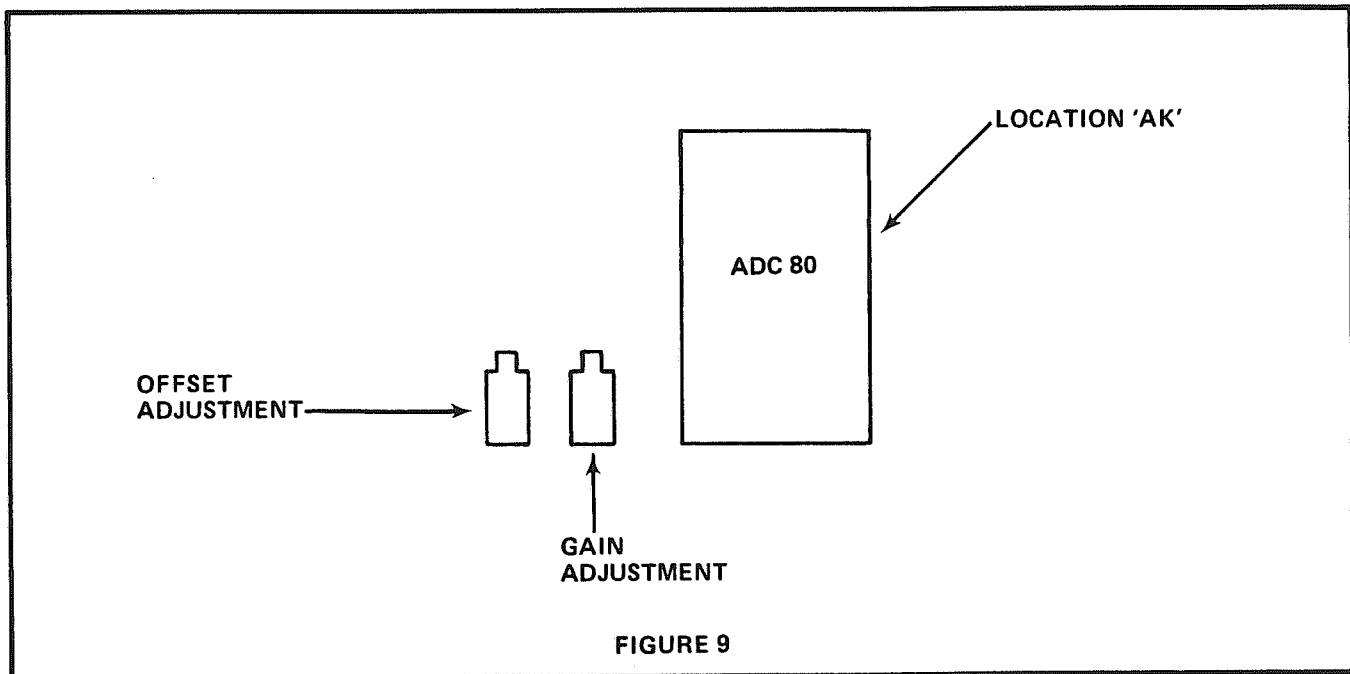

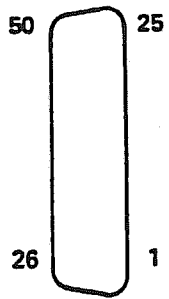

FACE VIEW

Socket/Wire List

50 SOCKET RIBBON CONN.

SOCKET NO.

SOCKET NO.

50	Ground
49	
48	
47	
46	
45	
44	
43	
42	
41	Channel 15-
40	Channel 14-
39	Channel 13-
38	Channel 12-
37	Channel 11-
36	Channel 10-
35	Channel 9-
34	Channel 8-
33	Channel 7-
32	Channel 6-
31	Channel 5-
30	Channel 4-
29	Channel 3-
28	Channel 2-
27	Channel 1-
26	Channel 0-

25	Ground
24	
23	
22	
21	
20	
19	
18	
17	
16	Channel 15+
15	Channel 14+
14	Channel 13+
13	Channel 12+
12	Channel 11+
11	Channel 10+
10	Channel 9+
9	Channel 8+
8	Channel 7+
7	Channel 6+
6	Channel 5+
5	Channel 4+
4	Channel 3+
3	Channel 2+
2	Channel 1+
1	Channel 0+

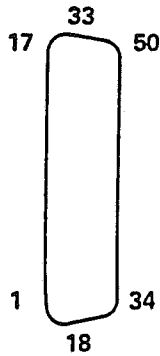

FACE VIEW

Pin/Wire List

50 PIN 'D'

<u>IN NO.</u>		<u>PIN NO.</u>		<u>PIN NO.</u>
17	Channel 7-			50
16	Channel 7+	33	Channel 15-	49
15	Channel 6-	32	Channel 15+	48
14	Channel 6+	31	Channel 14-	47
13	Channel 5-	30	Channel 14+	46
12	Channel 5+	29	Channel 13-	45
11	Channel 4-	28	Channel 13+	44
10	Channel 4+	27	Channel 12-	43
9	Channel 3-	26	Channel 12+	42
8	Channel 3+	25	Channel 11-	41
7	Channel 2-	24	Channel 11+	40
6	Channel 2+	23	Channel 10-	39
5	Channel 1-	22	Channel 10+	38
4	Channel 1+	21	Channel 9-	37
3	Channel 0-	20	Channel 9+	36
2	Channel 0+	19	Channel 8-	35
1	Ground	18	Channel 8+	34

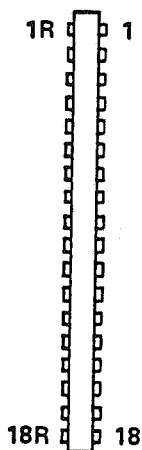

Pin/Wire List

18/36 POSTION P.C. EDGE

FACE VIEW

<u>PIN NO.</u>	
1R	_____
2R	Channel 0-
3R	Channel 1-
4R	Channel 2-
5R	Channel 3-
6R	Channel 4-
7R	Channel 5-
8R	Channel 6-
9R	Channel 7-
10R	Channel 8-
11R	Channel 9-
12R	Channel 10-
13R	Channel 11-
14R	Channel 12-
15R	Channel 13-
16R	Channel 14-
17R	Channel 15-
18R	Ground

<u>PIN NO.</u>	
1	_____
2	Channel 0+
3	Channel 1+
4	Channel 2+
5	Channel 3+
6	Channel 4+
7	Channel 5+
8	Channel 6+
9	Channel 7+
10	Channel 8+
11	Channel 9+
12	Channel 10+
13	Channel 11+
14	Channel 12+
15	Channel 13+
16	Channel 14+
17	Channel 15+
18	Ground

WARRANTY

KineticSystems Company, LLC warrants its standard hardware products to be free of defects in workmanship and materials for a period of one year from the date of shipment to the original end user. Software products manufactured by KineticSystems are warranted to conform to the Software Product Description (SPD) applicable at the time of purchase for a period of ninety days from the date of shipment to the original end user. Products purchased for resale by KineticSystems carry the original equipment manufacturer's warranty.

KineticSystems will, at its option, either repair or replace products that prove to be defective in materials or workmanship during the warranty period.

Transportation charges for shipping products to KineticSystems shall be prepaid by the purchaser, while charges for returning the repaired warranty product to the purchaser, if located in the United States, shall be paid by KineticSystems. Return shipment will be made by UPS, where available, unless the purchaser requests a premium method of shipment at their expense. The selected carrier shall not be construed to be the agent of KineticSystems, nor will KineticSystems assume any liability in connection with the services provided by the carrier.

The product warranty may vary outside the United States and does not include shipping, customs clearance, or any other charges. Consult your local authorized representative or reseller for more information regarding specific warranty coverage and shipping details.

PRODUCT SPECIFICATIONS AND DESCRIPTIONS IN THIS DOCUMENT SUBJECT TO CHANGE WITHOUT NOTICE.

KINETICSYSTEMS SPECIFICALLY MAKES NO WARRANTY OF MERCHANTABILITY OR FITNESS FOR A PARTICULAR PURPOSE OR ANY OTHER WARRANTY EITHER EXPRESSED OR IMPLIED, EXCEPT AS IS EXPRESSLY SET FORTH HEREIN. PRODUCT FAILURES CREATED BY UNAUTHORIZED MODIFICATIONS, PRODUCT MISUSE, OR IMPROPER INSTALLATION ARE NOT COVERED BY THIS WARRANTY.

THE WARRANTIES PROVIDED HEREIN ARE THE PURCHASER'S SOLE AND EXCLUSIVE REMEDIES ON ANY CLAIM OF ANY KIND FOR ANY LOSS OR DAMAGE ARISING OUT OF, CONNECTED WITH, OR RESULTING FROM THE USE, PERFORMANCE OR BREACH THEREOF, OR FROM THE DESIGN, MANUFACTURE, SALE, DELIVERY, RESALE, OR REPAIR OR USE OF ANY PRODUCTS COVERED OR FURNISHED BY KINETICSYSTEMS INCLUDING BUT NOT LIMITED TO ANY CLAIM OF NEGLIGENCE OR OTHER TORTIOUS BREACH, SHALL BE THE REPAIR OR REPLACEMENT, FOB FACTORY, AS KINETICSYSTEMS MAY ELECT, OF THE PRODUCT OR PART THEREOF GIVING RISE TO SUCH CLAIM, EXCEPT THAT KINETICSYSTEMS' LIABILITY FOR SUCH REPAIR OR REPLACEMENT SHALL IN NO EVENT EXCEED THE CONTRACT PRICE ALLOCABLE TO THE PRODUCTS OR PART THEREOF WHICH GIVES RISE TO THE CLAIM. IN NO EVENT SHALL KINETICSYSTEMS BE LIABLE FOR DIRECT, INDIRECT, SPECIAL, INCIDENTAL, OR CONSEQUENTIAL DAMAGES, INCLUDING LOSS OF PROFITS.

Products will not be accepted for credit or exchange without the prior written approval of KineticSystems. If it is necessary to return a product for repair, replacement or exchange, a Return Authorization (RA) Number must first be obtained from the Repair Service Center prior to shipping the product to KineticSystems. The following steps should be taken before returning any product:

1. Contact KineticSystems and discuss the problem with a Technical Service Engineer.
2. Obtain a Return Authorization (RA) Number.
3. Initiate a purchase order for the estimated repair charge if the product is out of warranty.
4. Include a description of the problem and your technical contact person with the product.
5. Ship the product prepaid with the RA Number marked on the outside of the package to:

KineticSystems Company, LLC
Repair Service Center
900 North State Street
Lockport, IL 60441

Telephone: (815) 838-0005
Facsimile: (815) 838-4424
Email: tech-serv@kscorp.com