

**KineticSystems Company, LLC
Preston Scientific
8300XWB A Amplifier
User's Manual**

January, 1999

(C) 1999
Copyright by
KineticSystems Company, LLC
Lockport, Illinois
All rights reserved

CONTENTS

1	Preston 8300XWB-A/B Series Amplifiers	1
1.1	Introduction	1
1.2	Specifications.....	1
2	Model 8300XWB Amplifier – Installation	5
2.1	Mounting	5
2.2	Wiring Connectors.....	5
3	Model 8300WXB Amplifier – Principles of Operation.....	7
3.1	Principles of Operation – General	7
4	Model 8300WXB Amplifier – Block Diagram & Typical Waveforms	8
4.1	Block Diagram.....	8
4.2	Waveform Test Points	8
5	Model 8300XWB Amplifiers – Maintenance & Troubleshooting	9
5.1	Performance Tests:	9
5.2	Gain Setting Accuracy:.....	9
5.3	Linearity Check:	9
5.4	Common Mode Rejection.....	10
5.5	Noise:.....	10
5.6	Overload Recovery Check:.....	11
5.7	Calibration:	11
5.8	RTO Zero Adjustment:	11
5.9	RTI Zero Adjustment.....	12
5.10	Gain Adjustment:.....	12
5.11	Model XWB/XWBRC Amplifier Troubleshooting	13
6	Model 8300XWB Amplifiers – Illustrations	15

8300 XWB SERIES

Floating Differential Amplifiers

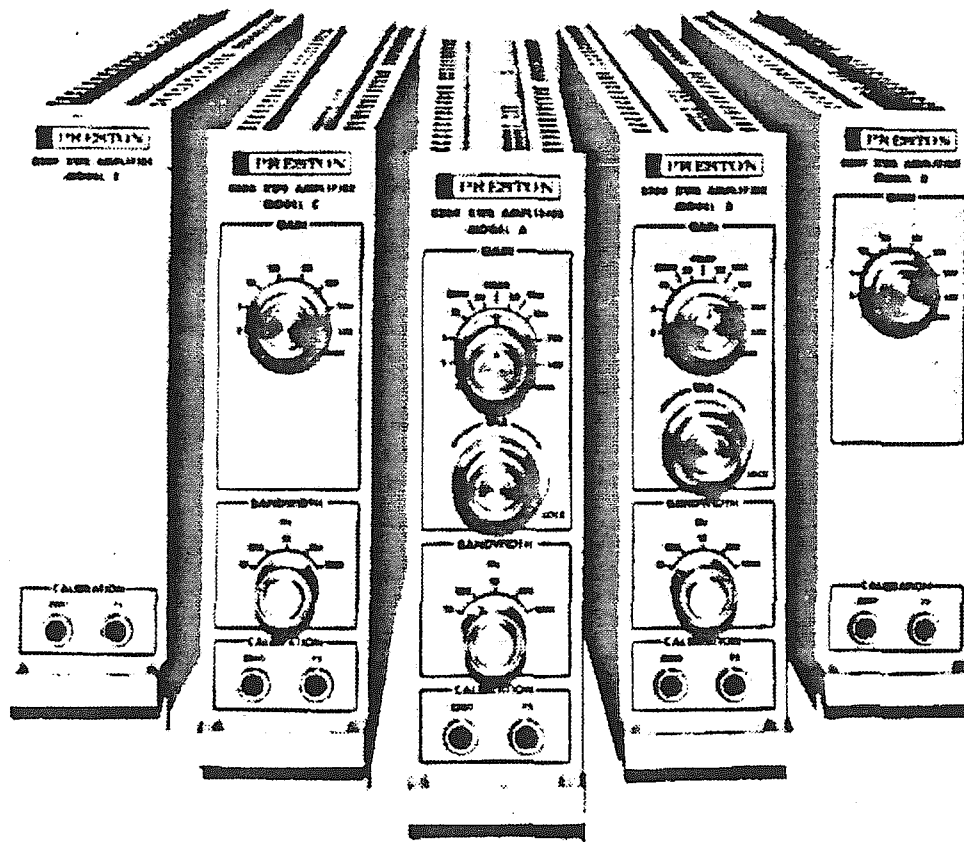

These amplifiers feature:

- Linearity $\pm 0.005\%$
- Drift $0.1 \text{ fV per } ^\circ\text{C}$
- Common mode voltage 350V
- Accuracy $\pm 0.01\%$
- Settling time 30 psec
- Common mode rejections
130 db @ 60 Hz
- Bandwidth 100 kHz
- Short circuit proof
- Self contained power supply

We turn the key... from A to D

8300 XWB DESCRIPTION & APPLICATIONS

The 8300 XWB Series Amplifier is a DC to 100 kHz, floating differential, low level, instrumentation amplifier which provides infinite isolation between the input and output circuits. Most XWB Models include switch-selectable gains from 1 to 1000 (up to 2500 with vernier gain control), switch-selectable full power bandwidths from 10 Hz to 100 kHz (-3 db points) and full scale output of ≈ 10 volts at 100 milliamps. In addition, all XWB Series Amplifiers offer a unique combination of features including 150 db common mode rejection (at all gain ranges), less than 3 microvolts of noise RTI and drift as low as 0.1 microvolts per degree C RTI or less than 1 millivolt for 50 degrees C RTO. XWB Series Amplifiers will meet all performance specification* for signals having a common mode voltage up to 350 volts peak AC or DC. The XWB Series Amplifier is assembled in a rock mountable "heavy duty" aluminum chassis using high reliability input/output connectors with an integral DC power supply capable of operation from either 115 volts or 220 volts 50 Hz to 60 Hz.

The 8300 XWB Series Amplifier offers unique combinations of capabilities and specifications, making it the most versatile amplifier for your most demanding instrumentation application. Any one model may be used in a wide variety of applications including low level signal conditioning requirements in noisy and high CMV environments; high gain or low gain isolation buffer amplifier for real time process control applications; pre-amplifier for digital voltmeters, data recorders, or Analog-to-Digital Converter*, driver amplifier for strip chart recorders, pen drives and oscillograph galvo's. The amplifier features extremely low drift, very low noise, high accuracy, and wide dynamic range (DC to 100 kHz) common mode rejection, while offering very fast overload recovery and on-scale settling times. The 8300 XWB is an outstanding DC Amplifier which meets our customers growing needs for a superior instrumentation amplifier.

COMMON specifications MODELS A, B, C, D, E

GAIN STABILITY	0.01% (six-month term)
SETTLING TIME (TO $\pm 0.01\%$ FULL SCALE)	100 kHz ... 30 μ sec 10 kHz ... 250 μ sec 1 kHz ... 2.5 msec 100 Hz ... 25 msec 10 Hz ... 250 msec
SLEWING RATE	3 volts per μ sec
COMMON MODE REJECTION	CMR ratio versus frequency is specified as follows, with an unbalance of 1000 ohms. ... 150 db at DC min; 130 db at 60 Hz min 110 db at 400 Hz min; 115 db at 400 Hz typ 65 db at 10 kHz typ
PLIMPOUT CURRENT	Less than 0.2 namps @ 25°C and less than 0.01 namps/°C
COMMON MODE VOLTAGE	350 volts maximum at peak AC/DC
CHOPPER INTERMODULATION	Less than 0.01%
INPUT NOISE (measurement bandwidth 300 kHz)	100 kHz ... Less than 3 μ volts RMS 10 kHz ... 10 μ volts P-P (1 μ volts RMS) 1 kHz ... 5 μ volts P-P 100 Hz ... 3 μ volts P-P 10 Hz ... 2 μ volts P-P
LONG TERM ZERO DRIFT	± 5 μ volts RTI ± 1 m volt RTO at $\pm 10\%$ line voltage (six-month term)
INPUT IMPEDANCE	100 Mohm shunted by less than 0.001 μ farad for all gains at DC
OUTPUT NOISE	Less than 0.5 m volts peak for 100 kHz at a measured bandwidth of 300 kHz
OVERLOAD RECOVERY	30 μ sec to within 0.01% of overload signal RTI, up to ± 20 volts
OUTPUT CAPABILITY	100 m amps at ± 5 volts or ± 10 volts full scale; capacity loads to 0.22 μ farads will not cause instability
OUTPUT IMPEDANCE	0.5 ohm max
POWER	115 or 220 volts $\pm 10\%$, 50 to 60 Hz
AMPLIFIER PROTECTION	The output is unconditionally short-circuit proof
OPERATING TEMPERATURE	0° to +50°C
DIMENSIONS	20.375 inches long (including connectors), 2.12 inches wide and 8.25 inches high
WEIGHT	8.5 pounds (shipping weight is 10.5 pounds)

AMPLIFIER technical specifications

MODEL A

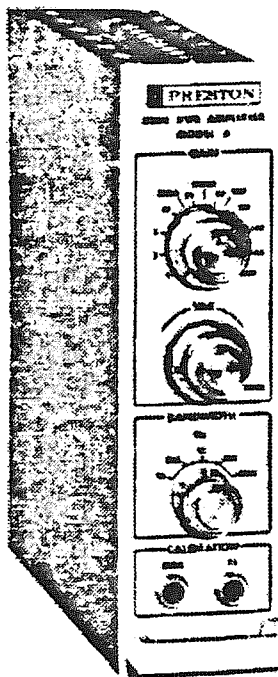

ELECTRICAL

- GAIN..... Ten fixed steps of 1, 2, 5, 10, 20, 50, 100, 200, 500 and 1000; variable between each step up to gain of 2500. Bandwidth for gains above 1000 limited to 40 kHz
- GAIN ACCURACY..... $\pm 0.01\% \pm 3 \mu\text{volts RTI}$
- GAIN LINEARITY..... $\pm 0.005\%$
- GAIN TEMPERATURE COEFFICIENT..... 10 ppm per degree C maximum
- BANDWIDTH..... Switch-selectable ... 10, 100, 1 kHz, 10 kHz and 100 kHz. Filter is a two-pole critically damped response with 12 db per octave roll-off.
- DRIFT..... 0.1 $\mu\text{volts per degree C RTI} \pm 20 \mu\text{volts per degree RTO}$

FRONT PANEL CONTROLS

- FUNCTION SWITCH..... A three-position rotary switch for selection of either fixed or variable gain modes or zero (shorted input)
- GAIN SWITCH..... A ten-position rotary switch for selection of fixed gains
- VARIABLE GAIN..... A ten-turn potentiometer with locking device for selection of any gain from 1 to 2500
- BANDWIDTH SWITCH..... A five-position rotary switch for selection of desired bandwidth
- CALIBRATION..... Screw-driver controls for zero and unity gain

MODEL B

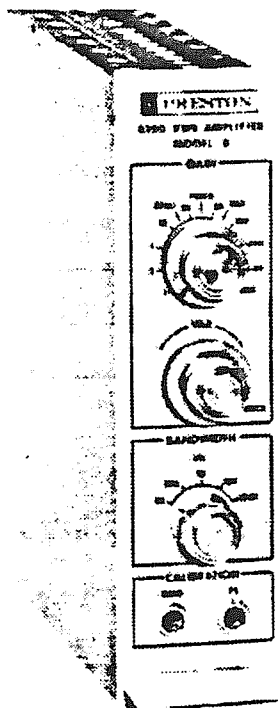

ELECTRICAL

- GAIN..... Ten fixed steps of 1, 2, 5, 10, 20, 50, 100, 200, 500 and 1000; variable between each step up to gain of 2500. Bandwidth for gains above 1000 limited to 40 kHz
- GAIN ACCURACY..... $\pm 0.01\% \pm 3 \mu\text{volts RTI}$
- GAIN LINEARITY..... $\pm 0.01\%$
- GAIN TEMPERATURE COEFFICIENT..... 20 ppm per degree C maximum
- BANDWIDTH..... Switch-selectable ... 10, 100, 1 kHz, 10 kHz and 100 kHz. Filter is a two-pole critically damped response with 12 db per octave roll-off.
- DRIFT..... 0.3 $\mu\text{volts per degree C RTI} \pm 100 \mu\text{volts per degree C RTO}$

FRONT PANEL CONTROLS

- FUNCTION SWITCH..... A three-position rotary switch for selection of either fixed or variable gain modes or zero (shorted input)
- GAIN SWITCH..... A ten-position rotary switch for selection of fixed gains
- VARIABLE GAIN..... A ten-turn potentiometer with locking device for selection of any gain from 1 to 2500
- BANDWIDTH SWITCH..... A five-position rotary switch for selection of desired bandwidth
- CALIBRATION..... Screw-driver controls for zero and unity gain

AMPLIFIER technical specifications

MODEL C



ELECTRICAL

GAIN.....	Ten fixed steps of 1, 2, 5, 10, 20, 50, 100, 200, 500 and 1000
GAIN ACCURACY.....	$\pm 0.1\% \pm 3 \mu\text{volts RTI}$
GAIN LINEARITY.....	$\pm 0.01\%$
GAIN TEMPERATURE COEFFICIENT.....	20 ppm per degree C maximum
BANDWIDTH.....	Switch-selectable ... 10, 100, 1 kHz, 10 kHz and 100 kHz. Filter is a two-pole critically damped response with 12 db per octave roll-off.
DRIFT.....	0.3 $\mu\text{volts per degree C RTI}$ $\pm 100 \mu\text{volts per degree C RTO}$

FRONT PANEL CONTROLS

GAIN SWITCH.....	A ten-position rotary switch for selection of fixed gains
BANDWIDTH SWITCH.....	A five-position rotary switch for selection of desired bandwidth
CALIBRATION.....	Screw-driver controls for zero and unity gain

MODEL D



ELECTRICAL

GAIN.....	Ten fixed steps of 1, 2, 5, 10, 20, 50, 100, 200, 500 and 1000
GAIN ACCURACY.....	$\pm 0.1\% \pm 3 \mu\text{volts RTI}$
GAIN LINEARITY.....	$\pm 0.01\%$
GAIN TEMPERATURE COEFFICIENT.....	20 ppm per degree C maximum
BANDWIDTH*.....	Fixed 100 kHz (-3 db)
DRIFT.....	0.3 $\mu\text{volts per degree C RTI}$ $\pm 100 \mu\text{volts per degree C RTO}$

FRONT PANEL CONTROLS

GAIN SWITCH.....	A ten-position rotary switch for selection of fixed gains
CALIBRATION.....	Screw-driver controls for zero and unity gain

*Customer may specify reduced bandwidth as low as 10 Hz at no additional charge

MODEL E

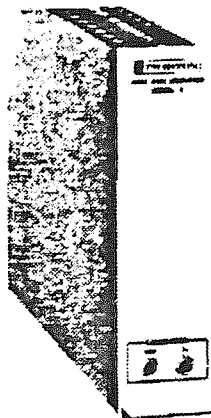

ELECTRICAL

GAIN.....	Any one fixed gain between 1 and 2000
GAIN ACCURACY.....	$\pm 0.01\% \pm 3 \mu\text{volts RTI}$
GAIN LINEARITY.....	$\pm 0.01\%$
GAIN TEMPERATURE COEFFICIENT.....	10 ppm per degree C maximum
BANDWIDTH*.....	Fixed 100 kHz (-3 db)
DRIFT.....	0.3 $\mu\text{volts per degree C RTI}$ $\pm 100 \mu\text{volts per degree C RTO}$

FRONT PANEL CONTROLS

CALIBRATION.....	Screw-driver controls for zero and unity gain
------------------	---

*Customer may specify reduced bandwidth of low at 10 Hz at no additional charge

OPTIONS

MODELS A, B, C

DUAL OUTPUTS	Two independent outputs; one filtered ± 10 volts ± 50 mamps, one unfiltered ± 10 volts ± 100 mamps.
MULTIPLEXER SWITCH.....	A solid state switch for multiplexing the filtered output. Requires external control logic which must be specified as either positive or negative true, 4 to 12 volts.

ACCESSORIES

MODEL 7600 RACK

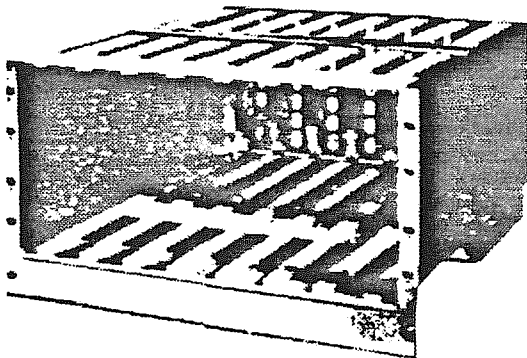

TECHNICAL SPECIFICATIONS, MODEL 7600 AMPLIFIER MOUNTING RACK

MOUNTING CAPACITY: The Model 7600 Rack will mount up to eight Preston amplifiers vertically. Blank panels are available for unused portions of the rack.

COOLING: The Model 7600 Rack is available either with or without three (3) 100 CFM muffin fans.

SIZE: The dimensions of the Model 7600 Rack are: 21.6 inches in length, including the rear connectors, - 19 inches in width; and 10.5 inches in height with cooling fans (8.75 inches without cooling fans).

WEIGHT: The Model 7600 Rack weighs 22 pounds (shipping weight is 45 pounds).

ELECTRICAL CONNECTORS: The input connector is an Amphenol No. 26-4201-8S; the output end power connector is an Amphenol No. 26-4201-165; and the AC power connector is an Amphenol No. 160-3.

MODEL 8020 RACK

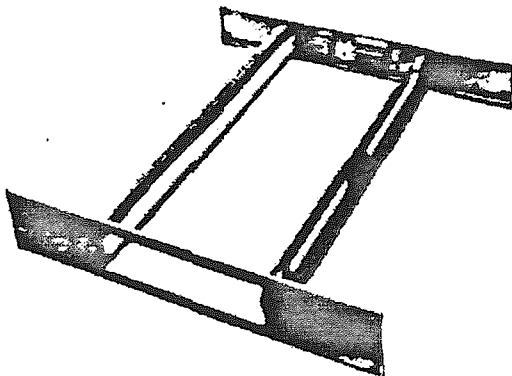

TECHNICAL SPECIFICATIONS, MODEL 8020 AND MODEL 14500 AMPLIFIER MOUNTING RACKS

MOUNTING CAPACITY: The Model 8020 Rack will mount one Preston Amplifier horizontally. The Model 14500 Rack (not shown) will mount two Preston Amplifiers horizontally.

SIZE: The dimensions of a Model 8020 or Model 14500 Rack are: 21.6 inches in length, including the rear connectors; 19 inches in width; and 3.5 inches in height.

WEIGHT: The Model 8020 and Model 14500 Racks weigh 10 pounds each (shipping weight is 17 pounds each).

ELECTRICAL CONNECTORS: The input connector is an Amphenol No. 26-4201-8S; the output and power connector is an Amphenol No. 26-4201-165. The Models 8020 and 14500 Racks are supplied with factory-wired AC power cords.

INSTRUMENTATION SYSTEM AMPLIFIERS

Programmable Gain and Bandwidth.

The Model "A" and "B" versions of the 6300 XWB Series Amplifiers are now available with programmable gain and bandwidth. These remotely controlled amplifiers identified by Model 8300 XWBRC—A and B are ideal for use in instrumentation systems where gain and bandwidth must be rapidly changed to optimize signal amplitude for digitizing purposes and to reduce the RTI noise level by controlling the bandwidth of the output signal.

As many as 10 gain levels between unity and a maximum gain of 2500 can be provided, and up to five different bandwidths in the range from 10 Hz to 100 kHz can also be included—all in the standard amplifier case.

Control of both gain and bandwidth can be accomplished by a 4 bit binary address at standard digital logic levels in fully automated and computer controlled instrumentation systems.

Options for System Interfacing.

Where system requirements include special performance features, Preston's instrumentation amplifiers can be delivered with a wide variety of options. For complete information, ask for our 'Amplifier Options' brochure.

1. Low Pass Filter—for 1 Hz cut-off frequency.
2. Four Pole Bessel Filter. Increases attenuation to 24 db/octave above cut-off frequency.
3. Dual and Triple Outputs.
4. Binary Gain Steps. 11 gain steps from 1 to 1024.
5. Output Coding. Electrical output signals that indicate gain and bandwidth settings.
6. Calibrate Relay. Internal relay switches to 'standard voltage for system calibration.
7. 110 Volt Overload Protection on Input Signal Lines.
8. Multiplexer Switch. External logic signal switches on internal multiplexer circuits for sampling by ADC or digital voltmeter.

ADDITIONAL PRESTON AMPLIFIERS

DX Series —Model A

Developed to deliver high accuracy, the specifications for these compact instrumentation amplifiers include

6 Selectable bandwidth

1 Hz, 10 Hz, 100 Hz, 1 kHz, and 10 kHz wide band.

7 Selectable Gains

10, 20, 50, 100, 200, 500 and 1000, plus variable gain.

Gain Accuracy

0.05%

Gain Linearity

0.005%

Settling Time

50 microseconds to within 0.01%.

Pumpout Current

Less than 1 nanoamp @ 25 °C
Less than 10 nanoamps @ 50 °C

Common Mode Rejection

130 db @ DC, 108 db @ 60 Hz
(@ K=1000)

Common Mode Voltage

10 volts peak.

Input Impedance

10 Megohms.

Input Noise (1 σ)

less than 3 microvolts @ 60kHz
2 microvolts @ 100 Hz.

Output Noise (1 σ)

Less than 200 microvolts.

Output Level

± 5 or ± 10 volts full scale at 100 milliamps max.

Size

1.64" wide, 6.4" high, 15.8" long

MX Serial — Model B

Now you can get all of Preston's "Balanced Precision" performance in the new 'compact' size!

Complete with five selectable bandwidths, 10 front-panel gain settings with variable gain from 1 to 2500, Common Mode Rejection above 120 db from DC to 60 Hz, Common Mode Voltage of 350 volts peak, 1/2 nanoamp pumpout current—and many other performance specifications found only in Preston's 8300 XWB Series—the new MX Series Model "B" is ideal for every application that requires the ultimate in performance.



THE 8300AU

The new 8300AU, a programmable amplifier system, offers unique combinations of capabilities and specifications, making it the most versatile amplifier for your most demanding instrumentation application. Via RS232 or IEEE488 interface, your computer can control all modes of calibration, gain, and filter selection. The system can also be controlled from the front panel of the 8300AU Master Control Unit.

Requiring less than 60% of the panel space of our other models of comparable performance, the 8300AU system includes individual controls for 12 switchable gain settings from 1 to 2048 with an optional continuous gain control up to a maximum gain of 3000, and eight switchable bandwidths from 1 Hz to a maximum bandwidth of 100kHz. The first seven bandwidth positions provide a 4-pole Butterworth (or Bessel) response filter.

Also plug-in mode cards are available for strain gauge, thermocouple, and RTD sensors. Additionally, a signal conditioning power supply is available with remote sensing. Calibration modes include shunt-resistance, voltage-substitution plus the ability to switch the power supply connection to the input of the amplifier for monitoring purposes.

This system's remote programmability plus the abilities of the calibration modes represents a significant costs and time savings over other methods employing manual calibration and adjustment techniques.

SPECIFICATIONS

INPUT

Impedance: 100 megohm minimum
shunted by 1500 PF
maximum for all gains.

Connection: 3 wires-high, low and guard.

Source: 1k ohms maximum to
meet spec.

**System Common
Mode Rejection:** 130dB DC to 60Hz with up
1k unbalance.

**System Common
Mode Voltage:** 350 volts peak AC or DC.

Bias Current: 1 nA at 25 degree C, plus/
minus 0.5nA per degree C.

Accuracy: 0.1% (0.01% optional)

Linearity: .01%

Stability: 0.01% for six months.
0.002 % for per Deg C.

Tempco.

OUTPUT

Capability: 10 volts peak at 20 mA max.

Impedance: Less than 1 Ohm,

Protection: The output is unconditionally short
circuit proof.

Slew rate: 1.5 volts/usec

Bandwidth: Less than 3dB down at 100kHz (10
volts peak to peak)
Full power bandwidth 50kHz.
(20 volts peak to peak)

Steps: 12 binary gain steps from
1 to 2048.

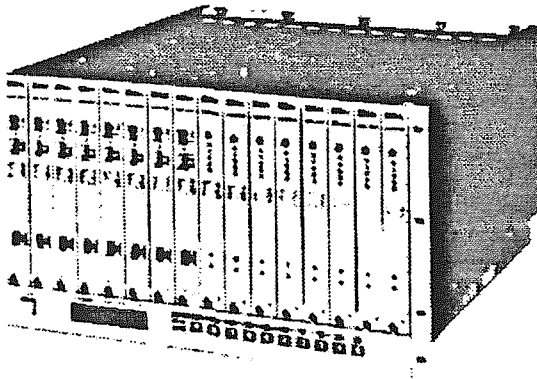

For additional information on these
Preston Amplifiers and other Preston
products, please contact your local
Preston representative.

1 Preston 8300XWB-A/B Series Amplifiers

1.1 Introduction

This document contains instructions for the operation and maintenance of the Preston 8300XWB- A/B Series amplifier noted on the title page.

The part number that describes this unit is located on the rear panel of the instrument. In addition, each unit is assigned a serial number unique to the particular piece of hardware to which it is attached. These numbers describe this instrument completely and should be referred to in all correspondence.

If for any reason this amplifier needs to be returned it should be shipped prepaid to the Lockport plant marked attention: Customer Service Department. A description of the problem or work to be done should be included as well as a phone number for a technical contact.

KineticSystems Company, LLC
900 N. State Street
Lockport, IL 60441

Telephone: (815) 838-0005
FAX: (815) 838-4424

1.2 Specifications

GENERAL

The Model 8300XWB Series Amplifier is a wideband, floating differential amplifier, that provides complete isolation between the input and output circuits. The unit also offers fast overload recovery and on-scale settling times.

It is ideally suited for any instrumentation application requiring high accuracy, very low noise, high input impedance, extremely low drift and high common mode rejection. The performance of this amplifier is not degraded by the length of the input cables, nor does it require the signal source to be grounded.

The models "A" and "B" have standard fixed gains from 1 to 1000 and bandwidths from 10 Hz to 10 kHz plus wideband (100kHz). Optional features included on a specific part number are listed below. In some cases information related to options may also be red-lined on the associated schematic.

Options:

The following options are included in Preston model 8300XWB amplifier, part number PR6276502.

MODEL:	A
INPUT VOLTAGE:	220VRMS ±10%, 50-60 Hz
MOUNTING:	Vertical
GAINS:	Standard
BANDWIDTHS:	Standard
OUTPUT:	Dual

Specifications

8300XWB Amplifier Specifications											
STANDARD FIXED GAINS:	1, 2, 5, 10, 20, 50, 100, 200, 500, 1000 Refer to (OPTIONS).										
VARIABLE GAIN RANGE:	Up to 2500 via front panel 10 turn locking potentiometer.										
GAIN ACCURACY:	$\pm 0.01\%$, ± 3 microvolts RTI, over the specified temperature range.										
GAIN LINEARITY:	$\pm 0.005\%$ full-scale ***MODEL -A $\pm 0.01\%$ full-scale ***MODEL -B										
GAIN TRIM:	Adjustable to within 0.01% by front panel potentiometer. Resolution to within 0.005%										
GAIN TEMPCO:	10 PPM per degree centigrade ***MODEL -A 20 PPM per degree centigrade ***MODEL -B										
GAIN STABILITY: Long term (6 mo.)	$\pm 0.01\%$ full-scale at the same temperature										
ZERO DRIFT:	0.1 microvolts per degree c RTI, *** MODEL -A ± 20 microvolts per degree C RTO										
ZERO DRIFT	0.3 microvolts per degree C RTI, *** MODEL -B ± 20 microvolts per degree C RTO										
LONG TERM ZERO DRIFT: (6 months)	± 5 microvolts RTI +1 millivolt RTO at same temperature and $\pm 10\%$ variation in line voltage										
ZERO TRIM:	A front panel recessed potentiometer is provided to adjust the output offset. The resolution is to .1 millivolts										
BANDWIDTH:	Less than 3 dB down at 100 kHz for all fixed gains at 20 volts peak-to-peak. The manually switched active filter has selectable cutoff frequencies to reduce the amplifier output bandwidth from 100 kHz. Rolloff beyond the -6 dB point is 12 dB per octave.										
FILTER ACCURACY:	Within $\pm 5\%$ of the 3 dB point										
CUTOFF FREQUENCIES: (Standard)	10 Hz, 100 Hz, 1 KHz, 10 KHz, 100 KHz Refer to (OPTIONS)										
FILTER RESPONSE:	Two-pole critically-damped (STANDARD)										
SETTLING TIME:	The amplifier settles to within $\pm 0.01\%$ of final value ± 10 microseconds at 100 kHz. Settling time increases proportionately as the bandwidth decreases. <table border="0" style="margin-left: auto; margin-right: auto;"> <thead> <tr> <th style="text-align: left;">SETTLING TIME</th> <th style="text-align: left;">BANDWIDTH</th> </tr> </thead> <tbody> <tr> <td>250 microseconds</td> <td>at 10 kHz</td> </tr> <tr> <td>2 milliseconds</td> <td>at 1 kHz</td> </tr> <tr> <td>25 milliseconds</td> <td>at 100 Hz</td> </tr> <tr> <td>250 milliseconds</td> <td>at 10 Hz</td> </tr> </tbody> </table>	SETTLING TIME	BANDWIDTH	250 microseconds	at 10 kHz	2 milliseconds	at 1 kHz	25 milliseconds	at 100 Hz	250 milliseconds	at 10 Hz
SETTLING TIME	BANDWIDTH										
250 microseconds	at 10 kHz										
2 milliseconds	at 1 kHz										
25 milliseconds	at 100 Hz										
250 milliseconds	at 10 Hz										
SLEWING RATE:	Exceeds 3 volts per microsecond										
COMMON MODE REJECTION: (minimum)	150 dB at DC 130 dB at 60 Hz 110 dB at 400 Hz 65 dB at 10 kHz										
CHOPPER INTERMODULATION:	Less than $\pm 0.01\%$ RTO										

8300XWB Amplifier Specifications													
	<p>The following specifications apply with the amplifier input shorted at a measurement bandwidth of 300 kHz.</p> <p style="text-align: center;">INPUT NOISE, REDUCED BANDWIDTH</p> <table style="margin-left: auto; margin-right: auto;"> <thead> <tr> <th style="text-align: center;">BANDWIDTH</th> <th style="text-align: center;">microvolts</th> </tr> </thead> <tbody> <tr> <td style="text-align: center;">100 kHz (wideband)</td> <td style="text-align: center;">3.5 RMS</td> </tr> <tr> <td style="text-align: center;">10 kHz</td> <td style="text-align: center;">11 peak-to-peak</td> </tr> <tr> <td style="text-align: center;">1 kHz</td> <td style="text-align: center;">7 peak-to-peak</td> </tr> <tr> <td style="text-align: center;">100 Hz</td> <td style="text-align: center;">5 peak-to-peak</td> </tr> <tr> <td style="text-align: center;">10 Hz</td> <td style="text-align: center;">2 peak-to-peak</td> </tr> </tbody> </table>	BANDWIDTH	microvolts	100 kHz (wideband)	3.5 RMS	10 kHz	11 peak-to-peak	1 kHz	7 peak-to-peak	100 Hz	5 peak-to-peak	10 Hz	2 peak-to-peak
BANDWIDTH	microvolts												
100 kHz (wideband)	3.5 RMS												
10 kHz	11 peak-to-peak												
1 kHz	7 peak-to-peak												
100 Hz	5 peak-to-peak												
10 Hz	2 peak-to-peak												
NOISE:													
PUMPOUT CURRENT:	200 picoamps nominal												
PUMPOUT CURRENT TEMPCO:	10 picoamps per degree C												
INPUT IMPEDANCE:	100 megohms minimum shunted by less than 0.001 microfarads for all gains at DC												
SOURCE CHARACTERISTICS:	The amplifier will meet all specifications with 0 to 1000 ohms source impedance in any unbalance. Length of input leads will not affect the operation of the amplifier. The source may be floating or grounded through any impedance.												
SINGLE OUTPUT:	± 10 volts at 100 milliamps filtered												
DUAL OUTPUT: (Optional)	± 10 volts at 50 milliamps filtered ± 10 volts at 100 milliamps unfiltered												
OUTPUT NOISE:	Less than 0.5 ohms at DC measured at the output connector of the amplifier												
OUTPUT IMPEDANCE:	Less than 0.5 ohms at DC measured at the output connector of the amplifier.												
CAPACITIVE LOADING:	Capacitive loads up to 0.22 microfarads will not cause instability.												
OVERLOAD RECOVERY:	The amplifier will recover from an overload of ± 20volts to within +0.01% of the overload signal RTI in 30 microseconds maximum. Recovery time increases proportionately as the bandwidth decreases (i.e., at 1 kHz, 2 milliseconds).												
POWER:	Each amplifier has an integral power supply and requires a line voltage of 105 to 130 volts RMS (or 205 to 235 volts RMS), 50 to 400 Hz. Step transients within the voltage range will not affect the amplifier.												
OUTPUT PROTECTION:	The amplifier output is unconditionally short circuit proof.												
OPERATING TEMPERATURE:	0 to +50 degrees C with relative humidity not to exceed 70%.												
STORAGE CONDITIONS:	-55 to +85 degrees C with relative humidities up to 95% without condensation.												
VIBRATION:	1 G or 0.1 inch double displacement, whichever is the limiting factor, over a range from 5 to 50 Hz.												
PRESSURE:	Sea level to 12,000 feet.												
CONNECTORS:	Input connector: Amphenol No. 26-4401- 8p Output connector: Amphenol No. 26-4401-16p												

8300XWB Amplifier Specifications	
MOUNTING:	The amplifier is available for vertical mounting in a Preston Model 7600-XWB Rack (8 amplifiers per Rack).
SIZE:	LENGTH: 20.375 inches including rear connectors WIDTH: 2.12 inches HEIGHT: 8.25 inches

2 Model 8300XWB Amplifier – Installation

2.1 Mounting

The amplifier is designed so that up to eight units may be mounted in a Preston Model 7600 Rack which in turn mounts in a standard 19 inch RETMA Relay Rack. The amplifier racks include the mating connectors for the appropriate number of amplifiers. Power wiring to the rack is provided.

The amplifier rack is designed so that the weight of the amplifier is distributed to a nylon support rail above and below the unit to prevent shock or vibration from placing undue strain on the front panel.

2.2 Wiring Connectors

PRIMARY POWER J2: The amplifier operates on an internal DC power supply capable of operation from either 115 or 230 volts RMS, 50 to 60 Hz. Refer to Section 1.1 (OPTIONS).

- **NOTE:** The AC power cord is polarized. Correct connections must be made with the power source. Despite the presence of a third grounding pin, there is no real assurance that the instrument will be wired correctly since the power outlets in many installations are erroneously wired. Be certain that the power source is in agreement with the power and grounding requirements of the instrument.

Before connecting the instrument, see that it is protected by a ½ amp 3 AG fuse. The fuse is readily accessible at the rear of the instrument.

SIGNAL INPUT J1: There are three input lines: Input HI, LO, and GUARD

INPUT LINE	PIN NUMBER			
HI	2,	7		
LO	3,	6		
GUARD	1,	4,	5,	8

Since the device operates as a differential amplifier, it will amplify the difference between the input HI and input LO.

AMPLIFIER OUTPUT J2: Standard 16-pin connector. Wiring for 32-Pin connector. Please refer to schematic.

OUTPUT #1	PIN NUMBER		OUTPUT #2	PIN NUMBER	
HI	1		HI	3	
LO	9		LO	11	
SHIELD	2	10	SHIELD	4	12

- **NOTE:** Option #2 is an option and may not apply

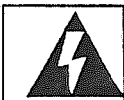

CAUTION: If you are not using a standard Preston Rack Adapter but instead are assembling your own mating connectors, please insure that the Pins 8 and 16 or 16 and 32 are toward the bottom of the amplifier. If this plug is inverted in its shell, serious damage to the amplifier will result

COOLING: The air surrounding the amplifier should be kept between 0 and +50 degrees C for proper operation. Storage temperature should be maintained between -20 and +85 degrees C.

Pin Connections for Output 3

Pin 5	OUTPUT	HI	#3
Pin 6	SHIELD		#3
Pin 13	OUTPUT	LO	#3
Pin 14	SHIELD		#3

3 Model 8300WXB Amplifier – Principles of Operation

3.1 Principles of Operation – General

Operation of the amplifier starts with the application of power and input signal. Refer to Section 7 (drawings) for proper connections (wiring diagram or schematic). After a thirty-minute stabilization period, the amplifier is ready for use.

The amplifier has a potentiometric stage. If the input is opened, the amplifier will go into saturation. Whenever the amplifier has power supplied and is not being used, the function switch should be placed in the ZERO position. The amplifier input will be opened at the connector and internally shorted, preventing the unit from going into saturation.

Since the front panel controls are dependent upon the user's requirements, different combinations appear on various models. All available controls are described in the following paragraphs.

GAIN: The gain is stated in OPTIONS.

FULL-SCALE POTENTIOMETER: The FS potentiometer (located on the front panel) calibrates the full-scale of the amplifier.

BANDWIDTH: The bandwidth is fixed active filter at the frequency listed in Section 1.1 (OPTIONS).

ZERO: The zero of the amplifier may be offset by the use of the ZERO ADJUST potentiometer located on the front panel. This control permits compensation for zero offsets in the amplifier and associated equipment.

RTI ZERO: The RTI ZERO adjustment is made with the amplifier in the highest gain. The amplifier must be set for a ZERO output by the front panel zero potentiometer in the lowest gain before an adjustment is attempted for the RTI ZERO. The RTI ZERO potentiometer is accessible through a hole in the top of the amplifier and is labeled on the right side panel as you face the amplifier.

4 Model 8300WXB Amplifier – Block Diagram & Typical Waveforms

4.1 Block Diagram

Figure 90052 is a simple block diagram of the XWB Series Amplifier. Its main sections are as follows:

- a) A chopper stabilized input amplifier, consisting of an AC amplifier, a chopper amplifier and a DC amplifier.
- b) A switching amplifier that drives the primary of a toroid transformer.
- c) The toroid transformer.
- d) A filtered output amplifier.

4.2 Waveform Test Points

Figure 90076 is a reduced picture of the component side of a typical printed circuit board. The test points that are specified letters A through M may be used in checking the amplifier for malfunction. Examples of each waveform at these test points appear in Figures 90053, 90054 and 90055.

For waveform results in Figure 90055, the input to the amplifier was a 10 volt peak triangular wave at 5 kHz and the gain was set at "1".

The scope settings and the test point used to produce the waveforms in Figures 90053 through 90055 are listed as follows:

FIGURE REF	TEST POINT IDENTIFICATION	SCOPE SETTING	
		SWEEP	SENSITIVITY
A	MC1	1 ms/cm	1 v/cm
B	MC2	1 ms/cm	1 v/cm
C	DC1	1 ms/cm	1 v/cm
D	DC2	1 ms/cm	1 v/cm
E	Chopper Output	1 ms/cm	1 v/cm
F	Switch Drive	200 nsec/cm	10 v/cm
G	D1	200 nsec/cm	10 v/cm
H	D2	200 nsec/cm	10 v/cm
I	DC Amp Output	50 μ s/cm	5 v/cm
J	Toroid Input	50 μ s/cm	5 v/cm
K	Toroid Output	50 μ s/cm	5 v/cm
L	Output of 0.01 ufd	50 μ s/cm	5 v/cm
M	Output of 0.047 ufd	50 μ s/cm	5 v/cm

5 Model 8300XWB Amplifiers – Maintenance & Troubleshooting

- **NOTE:** The following procedures apply to the 8300XWB and 8300XWB-RC family amplifiers, but all statements do not apply to all models. The model -E, for examples, has a single gain and bandwidth.

5.1 Performance Tests:

The procedures for operational checkout and calibration are described in this section, with the use of proper test equipment, safety precautions and minimum time taken into consideration.

5.2 Gain Setting Accuracy:

In order to properly check the gain setting accuracy, the specification (Section 1) should be noted.

A suggested test setup is shown in Figure 90056_99. Other types of setups may be used. The accuracy of the equipment should be at least +0.005%.

The test setup in Figure 90056_99 uses the comparison method and requires only one highly accurate test fixture. It should be noted that in all test setups, the use of proper shielding and grounding procedures are necessary.

The precision divider must have an accuracy of at least +0.005%, and a maximum output impedance of 500 ohms. It must have selectable steps to agree with amplifier gain steps per specifications in Section 1.

With the amplifier connected as shown in Figure 90056_99 and the power applied for at least ten minutes, the following procedure should be used.

- a) The zero potentiometer on the front panel should be adjusted for zero out.
- b) Set the Divider Power Supply to furnish full-scale output of the amplifier.
- c) Adjust the FS potentiometer on the front panel to the accuracy requirement of the amplifier specification.

5.3 Linearity Check:

The linearity of the amplifier may be checked by using the same setup as used for gain setting accuracy checking. The power supply voltage output must now be measured with a device accurate to +0.005% or better.

The typical gain and linearity plot shown in Figure 90057_99 reflects the requirements of the amplifier specification. This plot should be used for linearity checking. It should be noted that the plot reflects the 10-volt amplifier. For use with the 5 volts amplifier, this plot may be used by changing the volt reading to percent of full-scale and using 0.005% of 5 volts instead of 10 volts.

The linearity should be checked on each gain step by using the following procedure:

- a) Adjust the power supply for full-scale output.

- b) Adjust power supply to 80% of full-scale and check for error on the Null Balance indicator. This error should be within the amplifier specification.
- c) Adjust the power supply to 60%, 40% and 20% of full-scale and check for error per Paragraph (b) above.
- d) Reverse the polarity of the power supply and complete Paragraphs (a) through (c) above. This will give a linearity check from plus full-scale through minus full-scale.

An amplifier with dual outputs should be checked for output linearity on each output per the above checkout procedure. It should be noted that the amplifier specifications should be checked to determine the accuracy of the second output.

5.4 Common Mode Rejection

The common mode rejection may be checked by using a simple test setup as shown in Figure 90058_99.

The following test equipment is required to conduct the common mode rejection test:

- 1. A 1 MHz Oscilloscope
 - 2. An isolation transformer for safety
 - 3. A 10K resistor
 - 4. A 1K resistor.
-
- a) Connect the amplifier per Figure 90058_99. Set bandwidth switch for 250 Hz of next highest position. If amplifier has only frequencies below 250 Hz, set bandwidth switch to highest position.
 - b) Make sure the input plug is properly shielded to prevent radiation between the input and output plugs.
 - c) Apply power to amplifier and allow it to settle and warm up.
 - d) Plug in isolation transformers and apply power per Figure 90058_99.
 - e) Measure the signal on the scope. The peak-to-peak output should be less than 100 microvolts times the gain. The specification should be referred to due to some models having different common mode specifications.

5.5 Noise:

There are two types of noise to be measured for this amplifier Input noise and Output noise. It is recommended that a true RMS meter be Bused to measure the noise. If this is not available, a scope may be used.

- a) Connect the amplifier output to the true RMS meter.
- b) Set the gain switch to the unity (gain of one) position or lowest gain.
- c) The input should be shorted (concentric knob on gain switch set to OFF position, if applicable).
- d) Read the output noise. This should be within the required limits of the amplifier specification.

- e) Move the gain switch through each position and note the change in the reading. The change should not exceed the input noise specification times the gain.

5.6 Overload Recovery Check:

- a) Set amplifier GAIN switch to 1, or lowest gain.
- b) Set amplifier BANDWIDTH switch to wideband or highest bandwidth setting.
- c) Connect equipment per Figure 90060_99.
- d) Adjust Function Generator output to 20V peak-to-peak and frequency to 1kHz. The frequency may be varied to provide the best scope indication.
- e) Verify output 1 (and output 2, if DUAL OUTPUT option is included) settling time is within $\pm 0.01\%$ of final value ± 10 microvolts RTI in a maximum of 30 microseconds.
- f) Repeat for all gains.
- g) Set amplifier BANDWIDTH switch to next lower position and verify settling times to within $\pm 0.01\%$ of final value ± 10 microvolts RTI, on all gains per Table 1 below. Adjust Function Generator frequency as required.

SETTLING TIME	BANDWIDTH SETTING
250 microseconds	10 kHz
2 milliseconds	1 kHz
25 milliseconds	100 Hz
250 milliseconds	10 Hz

5.7 Calibration:

Most facilities require periodic checking of equipment to the manufacturer's specification. This section covers the adjustments that may be required at this time. The recommended times for periodic checking of the calibration is every six months.

5.8 RTO Zero Adjustment:

- a) Set Gain Switch to the 1, or lowest position.
- b) Set Bandwidth Switch to 10 Hz or lowest position.
- c) Short the input to the amplifier.
- d) Place the front panel ZERO potentiometer to approximate center of its rotation.
- e) Measure the amplifier output with the DVM. If the output is within $\pm 5\text{mV}$, use front panel ZERO potentiometer to adjust it to $0. \pm 1\text{mV}$.
- f) If the DVM indication is greater than $0. \pm 5\text{mV}$, use the RTO ZERO potentiometer to adjust it to $0. \pm 1\text{mV}$. Refer to Figure 90076 for the location of the RTO ZERO potentiometer. The amplifier cover must be removed to access this potentiometer.

5.9 RTI Zero Adjustment

- a) Prior to adjusting the RTI Zero, insure that the RTO is adjusted per the above paragraph.
- b) Set Gain Switch to the 1000, or highest position.
- c) Short the input to the amplifier.
- d) Adjust the RTI potentiometer (See Figure 90076) to obtain an output of $0.0V \pm 5mV$. The RTI potentiometer is accessible through a hole in the top rail of the amplifier and is indicated by labeling on the right-hand side panel.

5.10 Gain Adjustment:

- a) Connect the amplifier as shown in Figure 90056_99.
- b) Select lowest gain (usually 1)
- c) Set the divider to furnish either 5 or 10 volts, according to the amplifier's full-scale output specification.
- d) Measure the output and adjust the front panel FS potentiometer for the correct output.
- e) Reduce the input and select the next highest gain. Measure and adjust the corresponding gain potentiometer, if necessary. The adjustments of all gains, except the lowest gain, are accessible through the top rail of the amplifier, and each gain is labeled on the right-hand side of the outer cover.
- f) Check the output of each of the remaining gains while reducing the input to the correct value for the corresponding gain.

5.11 Model XWB/XWBRC Amplifier Troubleshooting

MODEL XWB/XWBRC AMPLIFIER TROUBLESHOOTING CHART	
The following list itemizes discrepancies and their probable causes. Please note that this is a general list for all XWB models and some of the items may not apply to your particular amplifier.	
(1) GAIN WILL NOT CALIBRATE	Defective 0.03% gain resistor adjacent to the gain with the largest error.
(2) EXCESSIVE GAIN	Guard to ground short, i.e.: shields touching, improperly positioned insulator on the gain switch.
(3) RTI ZERO OFFSET EXCESSIVE	No chopper signal usually U-1 chopper amplifier.
(4) RTI ZERO DRIFT EXCESSIVE	Q-3, potted chopper input F.E.T.
(5) RTI NOISE 1/f	Q-2, U-1, A1, or Q3
(6) RTI ZERO SLUGGISH RESPONSE TO ADJUSTMENT	U-1 chopper amplifier. (Low chopper gain).
(7) FAILS OVERLOAD RECOVERY	1N52241 zener diode at output of dc amplifier.
(8) DC AMPLIFIER OUTPUT OVERHEATS	Open 1N4148 diode, defective output resistor.
(9) AMPLIFIER OUTPUT 50% OF FULL-SCALE	Open 3200 ohm resistor in switch amplifier.
(10) NO SWITCH DRIVER SIGNAL AT TERMINALS 25 OR 26 WITH SIGNAL AT TERMINAL 65	Defective 61819 switch drive toroid. Defective 1N4148
(11) NON-LINEARITY	Q19, A35, value of 2.2 megohm resistor in linearity adjust circuit may require changing. If excessive, possible low power supply voltage at terminal 68 or 69 caused by defective 1N5231 zener diode.
(12) SWITCH AMPLIFIER OUTPUT TRANSISTORS AND/OR RESISTOR OVERHEATING	Open 1N4148 diode, defective transistor, or 61818 toroid.
(13) POWER SUPPLY OUT OF REGULATION	MC1709G regulator bad, or excessive loading because of defective component or output stage.
(14) FAILS COMMON MODE REJECTION	Shield shorting together, power transformer, or toroid.
(15) NO SIGNAL AT TERMINAL 64, ISOLATOR, INPUT AT TERMINAL 66 IS NORMAL	Defective demodulator D1, D2. Defective FET, Q48, 50, 52, 68. Shorted 0.0047 ufd capacitor at Q48.
(16) SWITCH DRIVE SIGNAL AT TERMINAL 65 LOW OR NON EXISTENT (TYPICAL OF A TEMPERATURE FAILURE)	If low, 61819 toroid loading. If missing isolate cause by checking multivibrator output of Q55 and Q56.
(17) FAILS OUTPUT IMPEDANCE	Low power supply voltage, defective 5230 diodes or Q40, Q41 in output amp.
(18) RELAY k-1 FAILS (FOR P/N 61850 ONLY)	Low power supply voltage, defective 5230 diodes, or Q40, Q41 in output amp. DOES NOT APPLY TO XWB-E
(19) FAILS 100 kHz FREQUENCY RESPONSE marginally	Q50, 200 picofarad capacitor at terminal 4943 picofarad capacitor at terminal 55. MAY NOT APPLY TO XWB-E
(20) FAILS BANDWIDTH	Defective filter capacitor.
(21) EXCESSIVE ZERO SHIFT	Q35, 18, 17, 19.
(22) EXCESSIVE GAIN DRIFT	Q19, 35 or 61818 isolator toroid.

MODEL XWB/XWBRC AMPLIFIER TROUBLESHOOTING CHART		
(23)	BECOMES INOPERATIVE DURING TEMPERATURE TEST	61819 switch toroid. Defective output transistor. DC amplifier, SW amplifier or output amplifier.
(24)	SOAKAGE WITH APPLICATION OF A SIGNAL OR POLARITY CHANGE	Check Q19.
(25)	SOAKAGE IN A SPECIFIC BANDWIDTH	Defective filter capacitor
(26)	CHOPPER WAVEFORM BAD ()	<p>Check waveforms at DC1 (21), DC2 (22), MC1 (18), MC2 (17). To isolate those circuits from chopper, remove taper pins at DC1, DC2, MC1, MC2.</p> <p>Short test point 1 to upper ground (Short for only a few seconds at a time). If chopper waveform tries to settle, there is a problem in the AC or DC amplifier that is upsetting the chopper.</p> <p>Defective U1 MC1709CG Defective Q15 or Q16 (2N5457).</p> <p>Short momentarily around the 56 microfarad capacitor going to point "B" of Q1.</p>
(26a)	SPIKES ON (MC1 & DC2) SPIKES ON (MC2 & DC1)	Defective Q30 Defective Q29
(27)	AMPLIFIER DOES NOT PASS A 10 VOLT SIGNAL AT UNITY GAIN	<p>Follow signal through AC amplifier (use lower ground). DC amplifier Switching amplifier (use upper ground).</p> <p>Isolator output taper pin 64 (use lower ground). Output amplifier (use lower ground). All of the above to determine which stage is not passing signal.</p>
(28)	INTERMITTENT PROBLEMS	Loose taper pins.
(29)	LINEARITY BAD	1N5241 zener diode oscillates.
(30)	NOISE ON 100 kHz BANDWIDTH	Check shielded cable at terminal 49 and 50 (BANDWIDTH SWITCH).
(31)	OPEN PRIMARY ON T1 POWER TRANSFORMER	Check that the interconnected windings of the transformer are properly terminated as per the schematic and wiring diagram.
(32)	LARGE 60 HZ RTI STEP OR SPIKE	T-1 Transformer shielding problem

6 Model 8300XWB Amplifiers – Illustrations

The following illustrations are included in this section:

FIGURE 90052	AMPLIFIER BLOCK DIAGRAM
FIGURE 90053	WAVEFORM EXAMPLES
FIGURE 90054	WAVEFORM EXAMPLES
FIGURE 90055	WAVEFORM EXAMPLES
FIGURE 90056_99	GAIN AND LINEARITY CIRCUIT
FIGURE 90057_99	GAIN AND LINEARITY PLOT
FIGURE 90058_99	COMMON MODE TEST CIRCUIT
FIGURE 90060_99	OVERLOAD RECOVERY TEST SETUP
FIGURE 90076	XWB AMPLIFIER BOARD ASSEMBLY POINT LOCATIONS

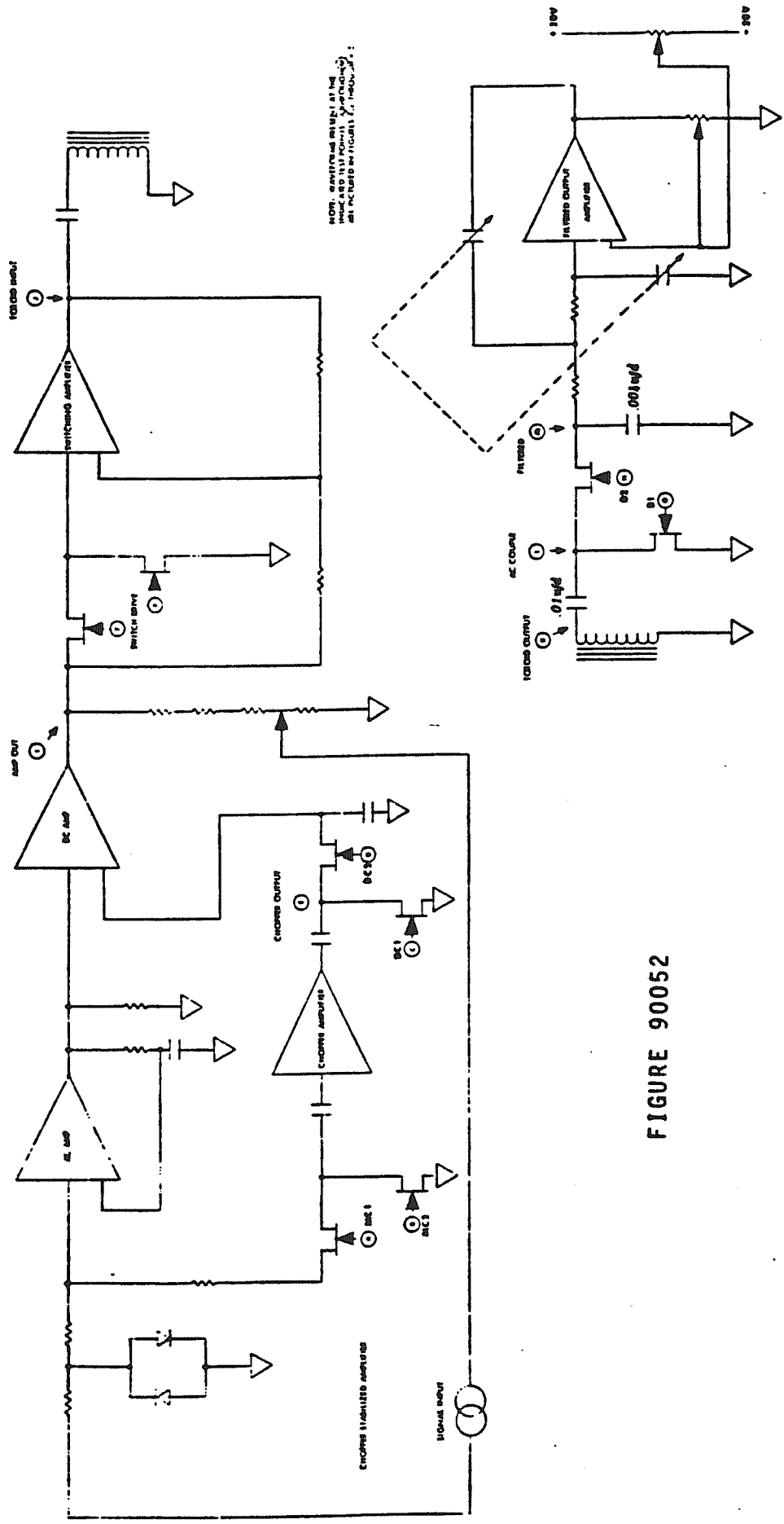

FIGURE 90052

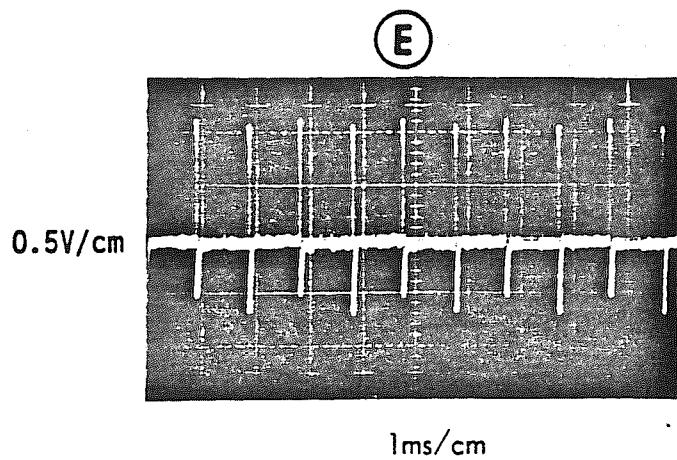
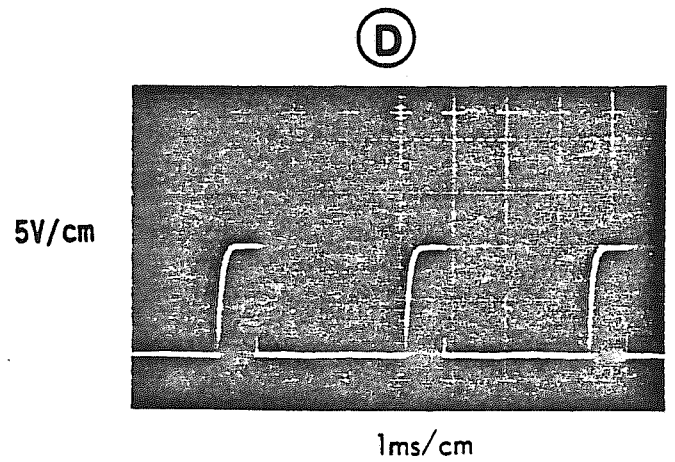
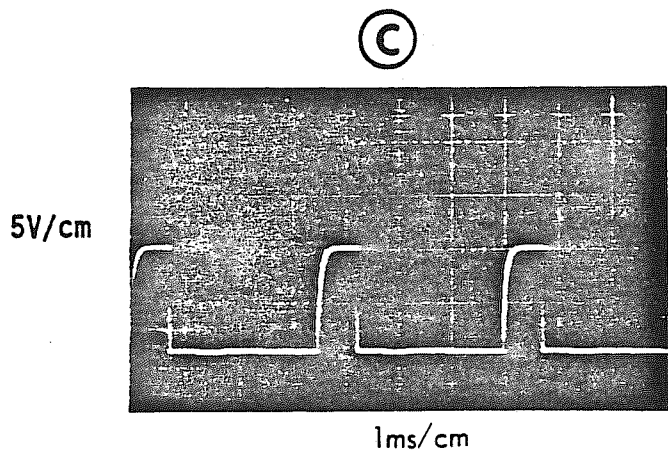
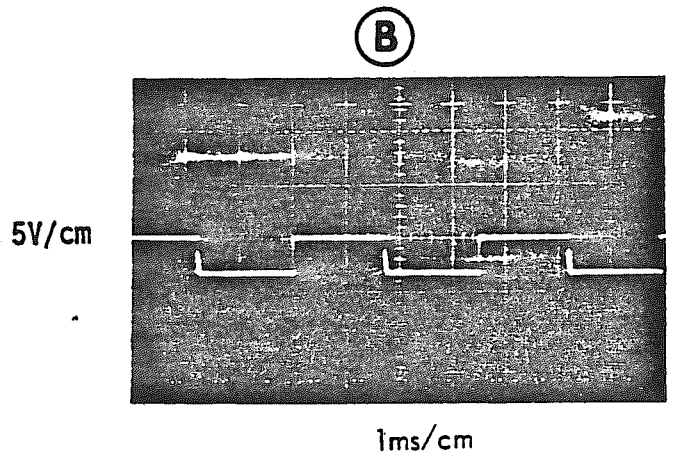
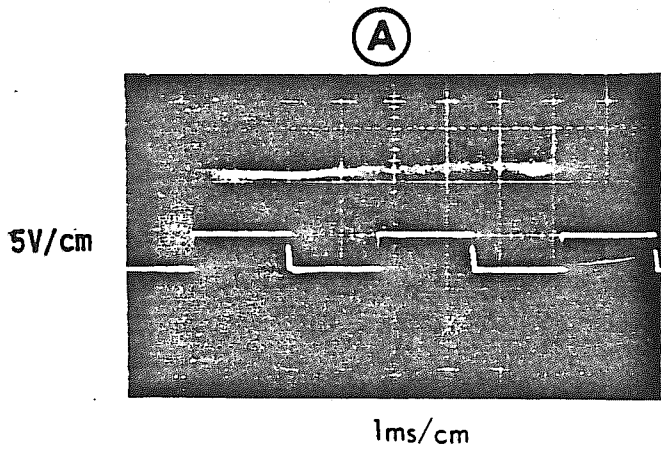
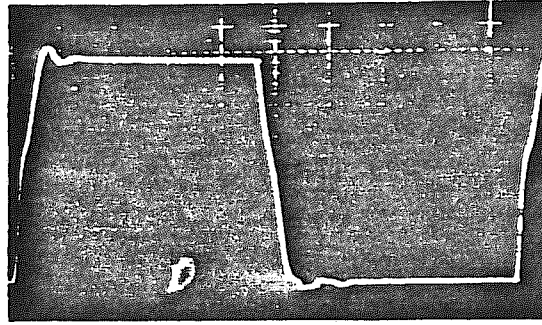

FIGURE 90053

(F)

10V/cm



200ns/cm

SWITCH DRIVE

(G)

10V/cm

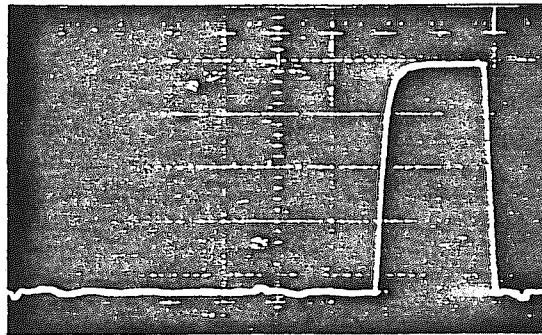

200ns/cm

D1

(H)

10V/cm

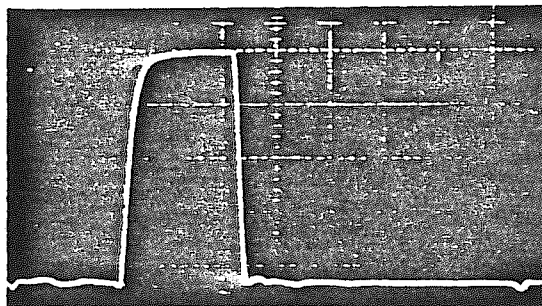

200ns/cm

D2

FIGURE 90054

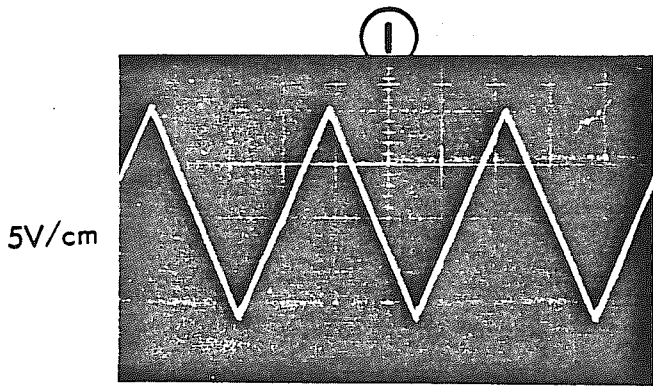

50us/cm

DC AMP OUTPUT

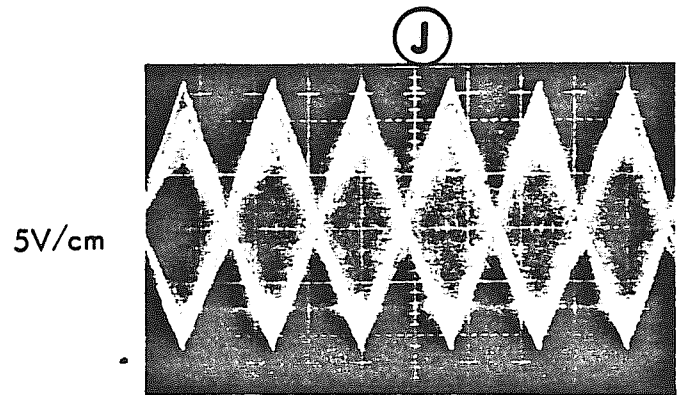

50us/cm

TOROID INPUT

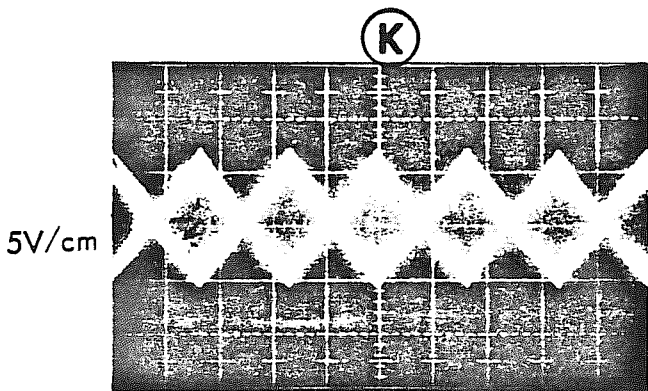

50us/cm

TOROID OUTPUT
INPUT OF 0.01ufd

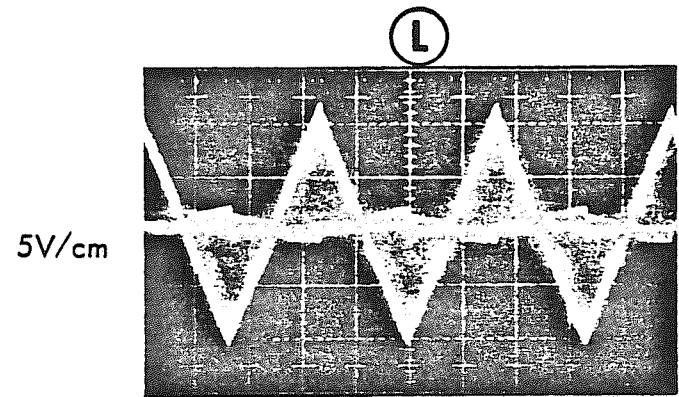

50us/cm

OUTPUT OF 0.01ufd

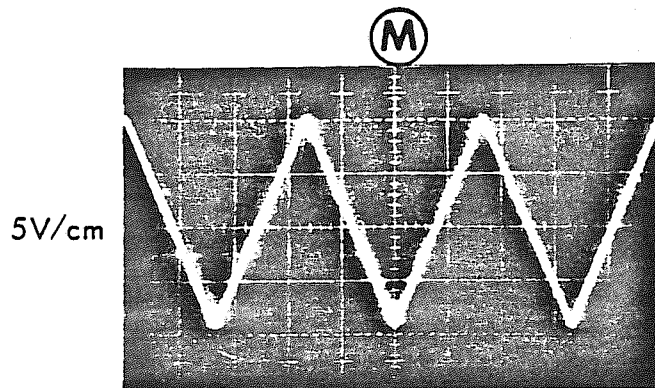

50us/cm

OUTPUT OF 0.004ufd

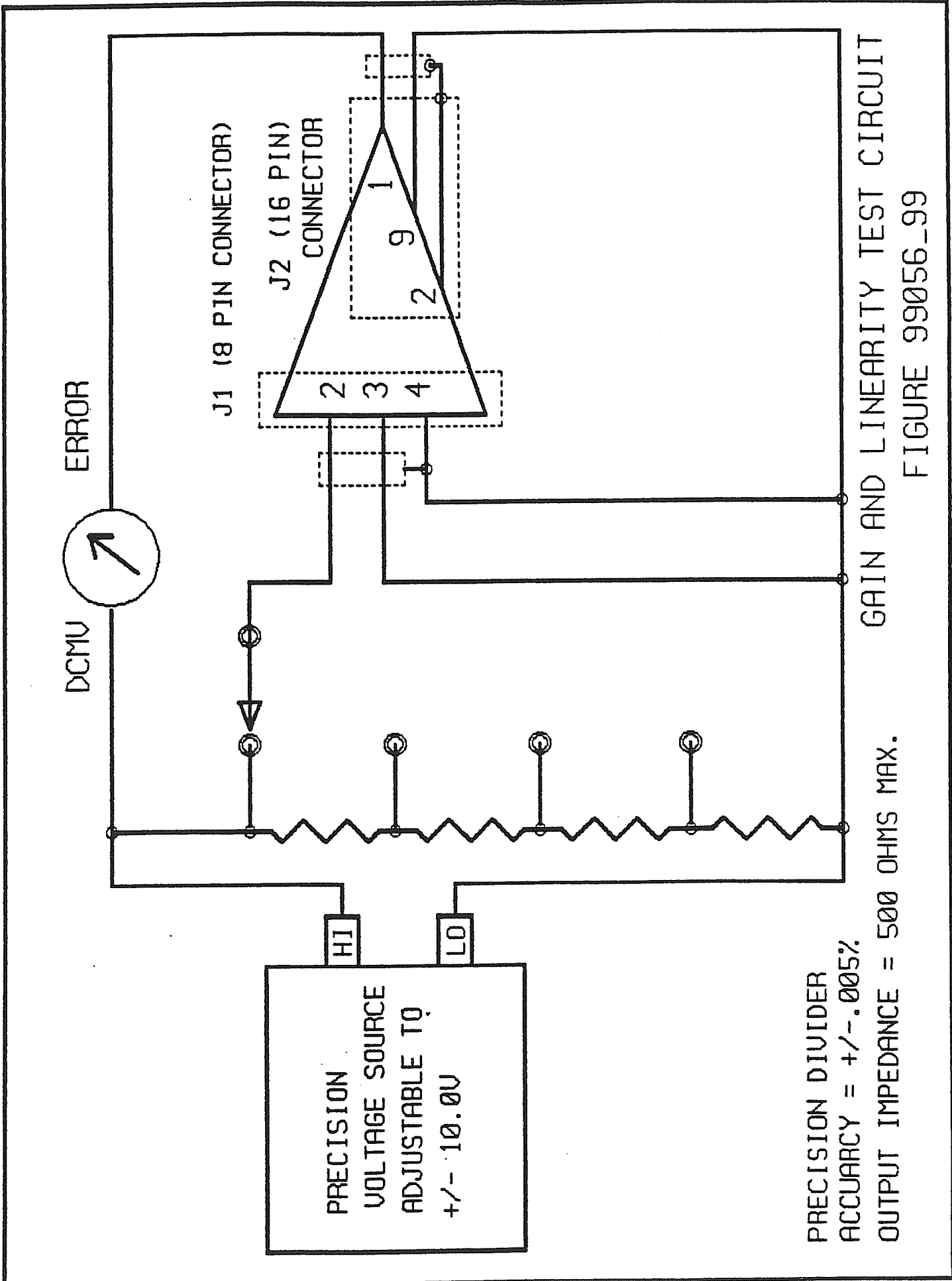

DCMU

ERROR

J1 (8 PIN CONNECTOR)

J2 (16 PIN)
CONNECTOR

PRECISION
VOLTAGE SOURCE
ADJUSTABLE TO
 $\pm 10.0\text{V}$

HI

LD

PRECISION DIVIDER
ACCURACY = $\pm 0.005\%$
OUTPUT IMPEDANCE = 500 OHMS MAX.

GAIN AND LINEARITY TEST CIRCUIT

FIGURE 99056-99

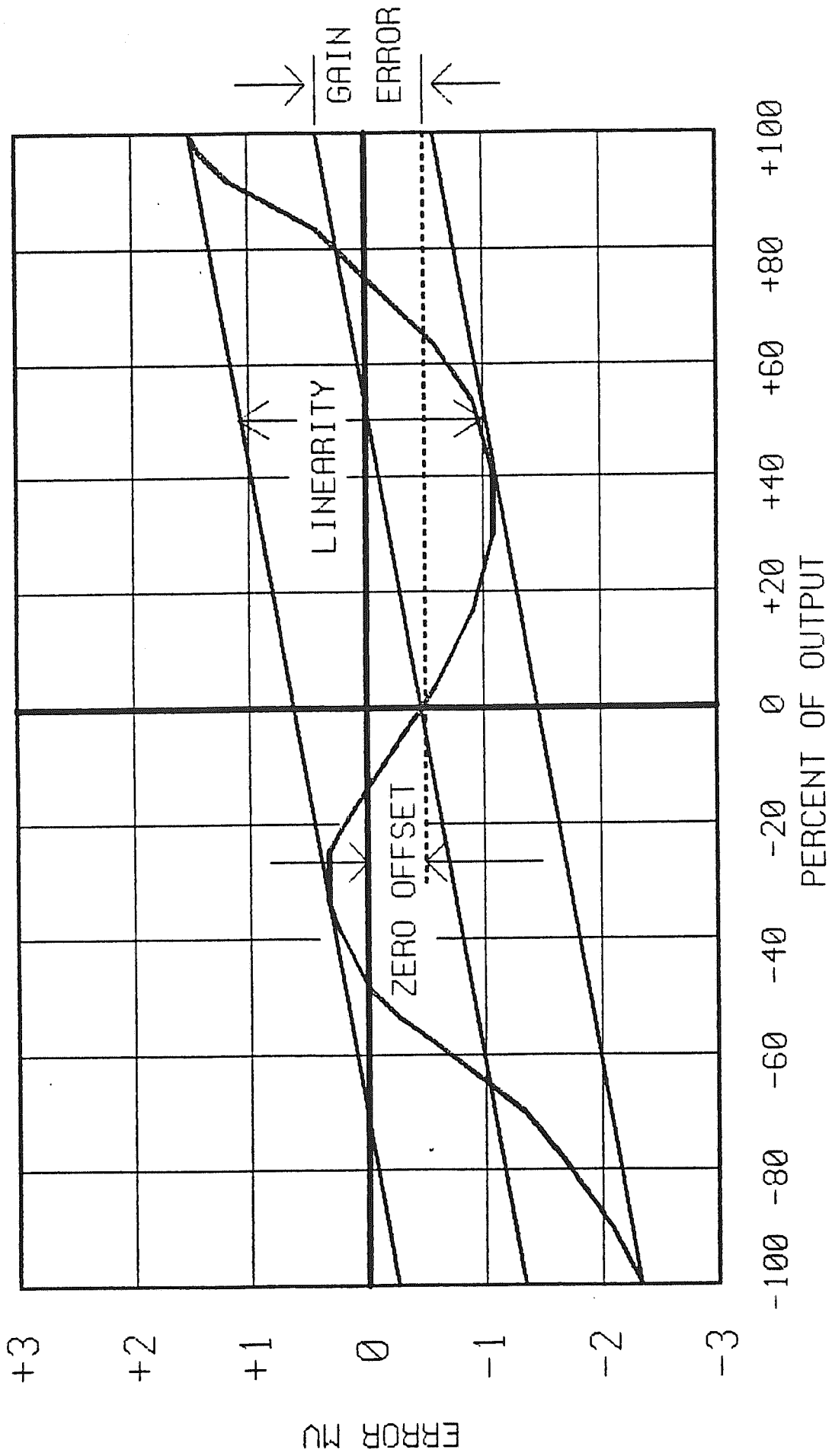

TYPICAL GAIN AND LINEARITY PLOT

FIGURE 90057-99

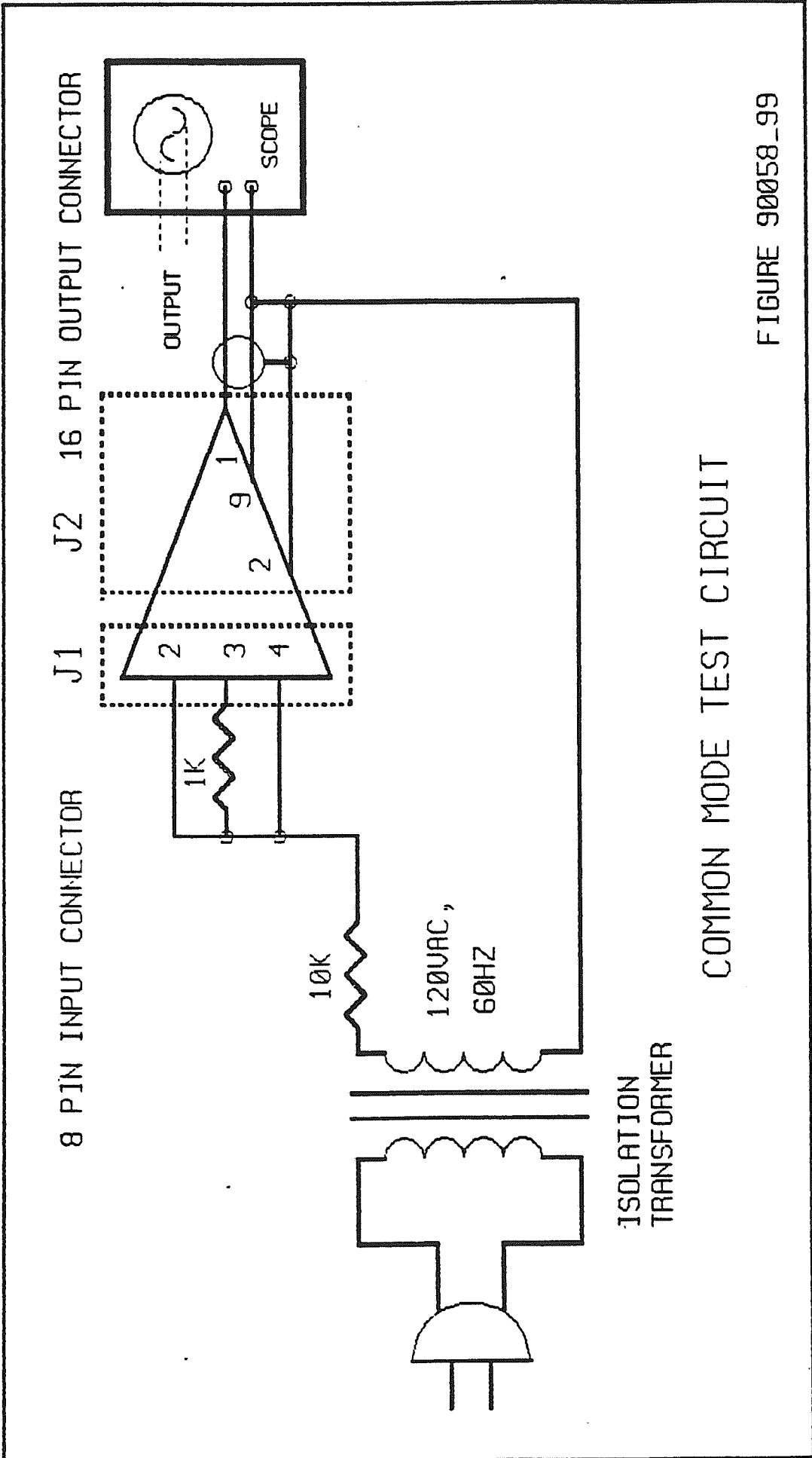

COMMON MODE TEST CIRCUIT

FIGURE 90058_99

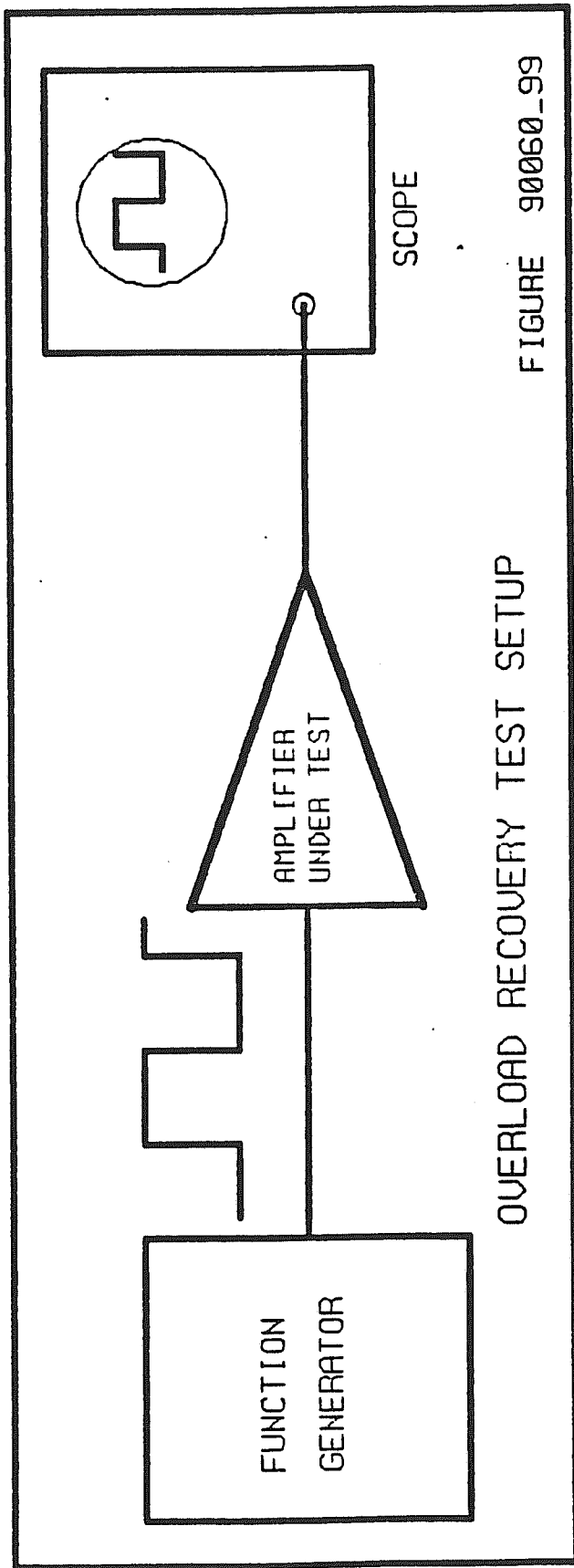

OVERLOAD RECOVERY TEST SETUP

FIGURE 90060_99

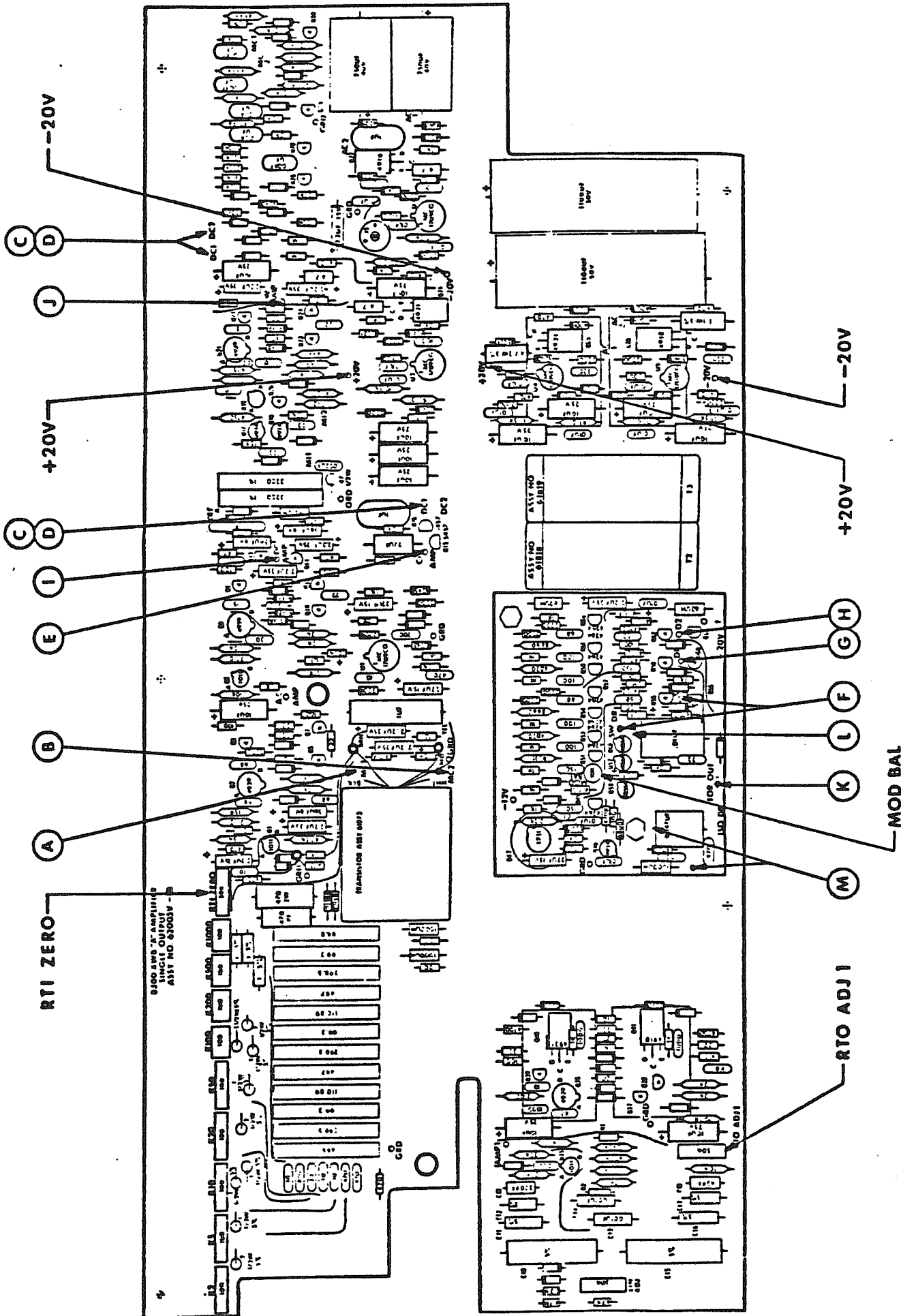

FIGURE 90076

WARRANTY

KineticSystems Company, LLC warrants its standard hardware products to be free of defects in workmanship and materials for a period of one year from the date of shipment to the original end user. Software products manufactured by KineticSystems are warranted to conform to the Software Product Description (SPD) applicable at the time of purchase for a period of ninety days from the date of shipment to the original end user. Products purchased for resale by KineticSystems carry the original equipment manufacturer's warranty.

KineticSystems will, at its option, either repair or replace products that prove to be defective in materials or workmanship during the warranty period.

Transportation charges for shipping products to KineticSystems shall be prepaid by the purchaser, while charges for returning the repaired warranty product to the purchaser, if located in the United States, shall be paid by KineticSystems. Return shipment will be made by UPS, where available, unless the purchaser requests a premium method of shipment at their expense. The selected carrier shall not be construed to be the agent of KineticSystems, nor will KineticSystems assume any liability in connection with the services provided by the carrier.

The product warranty may vary outside the United States and does not include shipping, customs clearance, or any other charges. Consult your local authorized representative or reseller for more information regarding specific warranty coverage and shipping details.

PRODUCT SPECIFICATIONS AND DESCRIPTIONS IN THIS DOCUMENT SUBJECT TO CHANGE WITHOUT NOTICE.

KINETICSYSTEMS SPECIFICALLY MAKES NO WARRANTY OF MERCHANTABILITY OR FITNESS FOR A PARTICULAR PURPOSE OR ANY OTHER WARRANTY EITHER EXPRESSED OR IMPLIED, EXCEPT AS IS EXPRESSLY SET FORTH HEREIN. PRODUCT FAILURES CREATED BY UNAUTHORIZED MODIFICATIONS, PRODUCT MISUSE, OR IMPROPER INSTALLATION ARE NOT COVERED BY THIS WARRANTY.

THE WARRANTIES PROVIDED HEREIN ARE THE PURCHASER'S SOLE AND EXCLUSIVE REMEDIES ON ANY CLAIM OF ANY KIND FOR ANY LOSS OR DAMAGE ARISING OUT OF, CONNECTED WITH, OR RESULTING FROM THE USE, PERFORMANCE OR BREACH THEREOF, OR FROM THE DESIGN, MANUFACTURE, SALE, DELIVERY, RESALE, OR REPAIR OR USE OF ANY PRODUCTS COVERED OR FURNISHED BY KINETICSYSTEMS INCLUDING BUT NOT LIMITED TO ANY CLAIM OF NEGLIGENCE OR OTHER TORTIOUS BREACH, SHALL BE THE REPAIR OR REPLACEMENT, FOB FACTORY, AS KINETICSYSTEMS MAY ELECT, OF THE PRODUCT OR PART THEREOF GIVING RISE TO SUCH CLAIM, EXCEPT THAT KINETICSYSTEMS' LIABILITY FOR SUCH REPAIR OR REPLACEMENT SHALL IN NO EVENT EXCEED THE CONTRACT PRICE ALLOCABLE TO THE PRODUCTS OR PART THEREOF WHICH GIVES RISE TO THE CLAIM. IN NO EVENT SHALL KINETICSYSTEMS BE LIABLE FOR DIRECT, INDIRECT, SPECIAL, INCIDENTAL, OR CONSEQUENTIAL DAMAGES, INCLUDING LOSS OF PROFITS.

Products will not be accepted for credit or exchange without the prior written approval of KineticSystems. If it is necessary to return a product for repair, replacement or exchange, a Return Authorization (RA) Number must first be obtained from the Repair Service Center prior to shipping the product to KineticSystems. The following steps should be taken before returning any product:

1. Contact KineticSystems and discuss the problem with a Technical Service Engineer.
2. Obtain a Return Authorization (RA) Number.
3. Initiate a purchase order for the estimated repair charge if the product is out of warranty.
4. Include a description of the problem and your technical contact person with the product.
5. Ship the product prepaid with the RA Number marked on the outside of the package to:

KineticSystems Company, LLC
Repair Service Center
900 North State Street
Lockport, IL 60441

Telephone: (815) 838-0005
Facsimile: (815) 838-4424
Email: tech-serv@kscorp.com