



DAQ400 Series 32/64 Channel Signal Conditioning Unit Instruction Manual



This Document Applies to:
DAQ432
DAQ464
VersaDAQ Software
DAQ750-464 Termination Panel

April 10, 2007

Table of Contents

DAQ400 Series – Data Sheet	1
32/64 Channel Signal Conditioning Unit.....	1
General Description.....	2
Ordering Information.....	5
Related Products	5
Model DAQ750-464	6
Unpacking	7
Front Panel Information - LEDs.....	8
Reset Button	9
Connectors.....	9
Grounding and Shield Termination.....	9
Analog Input Channels.....	9
Temperature Measurement.....	10
Frequency Measurement Channels	10
External Triggering.....	11
Front Panel Connectors	12
Hardware Setup	17
VersaDAQ Software.....	18
Getting Started.....	18
Importing and Exporting Configuration Settings	18

Configuring the DAQ via Ethernet Connection	19
Configuring the IP Address	21
Configuring the DAQ via CompactFlash	23
Configuring the Local Computer for Peer-to-peer Connections	24
Creating a Configuration	27
Operations Tab	28
Synchronization	29
Channels Tab	29
Selecting Channels to Modify	30
Channel Properties	31
Display Tab	32
Real Time Displays	33
Trigger Tab	34
Record Tab	35
Start Data Acquisition	38
Viewing Recorded Data	39
Data Converter Tool	40
EU Calibration Tool	41
Glossary	44
Technical Support and Warranty	48
Feedback	51

DAQ400 Series – Data Sheet

32/64 Channel Signal Conditioning Unit

Features

- 32/64 Differential input analog channels with signal conditioning
- 2 Additional Frequency Measurement channels
- 10 BaseT Ethernet connectivity to your PC or laptop for setup, data display and processing
- Wireless Ethernet available
- 16-bit analog-to-digital converter resolution
- Programmable gain from 1 to 128, on an individual channel basis, supports a wide variety of signals
- Programmable number of active channels
- Maximum sampling rate of 4k samples/second
- Simple user interface allows quick setup for data collection and storage
- Local data storage via CompactFlash™ module
- Auto-configuration on power-up for stand-alone applications
- External trigger input is provided

Typical Applications

- In-vehicle testing - Automotive testing
- Aircraft engine testing
- Motorcycle/ATV testing
- Boat/Marine engine testing
- Temperature measurement
- Pressure measurement
- 4-20mA control loop monitoring
- General analog monitoring

General Description

The *DAQ400 Systems* are complete 32 or 64 channel, multiplexed signal conditioning systems with a 16-bit resolution ADC and 10 BaseT Ethernet connectivity to a PC or laptop for setup, data display and processing. The ultra-compact fully enclosed chassis weighs just 1.09kg (2.4lbs), making it suitable for in-vehicle applications. The *DAQ Systems* can be powered from DC voltage sources ranging from 10-18 volts. Power consumption is 8 watts for the *DAQ432* and 9 watts for the *DAQ464*. Local data storage is available via a CompactFlash™ module. Auto configuration on power-up provides stand-alone capability and, along with the simple user interface, makes data collection and storage a quick process.

Signal conditioning consists of 32 or 64 multiplexed differential input analog channels with 100Hz low-pass filters and eight software programmable gain choices from 1 to 128, in a binary progression. Gain is programmable on an individual channel basis, allowing one *DAQ432* or *DAQ464* to measure a wide variety of signal input types (such as thermocouples, high-level inputs, etc.).

In addition to the analog channels, two channels of Frequency Measurement are provided. One of these channels can be configured as an external trigger input.

Signal conditioning channels are connected via a 68-position high density SCSI connector (two 68-position connectors for the *DAQ464*) or through an available DAQ750 Termination Assembly. Frequency Measurement channels are connected via a 15-contact "D" connector.

VersaDAQ software manages and controls *DAQ Systems* operations including setup, data acquisition, and data recording. *VersaDAQ* runs on a PC/laptop and connects to a *DAQ Series* chassis via the 10 BaseT Ethernet Connection. *VersaDAQ*'s simple but powerful user interface configures channels, sample rate, record mode, and all other *DAQ Systems* functionality with a few mouse clicks and pull-down menu selections.

DAQ400 Series Data Sheet continued.....

Item	Specification
Number of channels	DAQ432: 32 Channels (31 differential analog input channels, with channel 1 configured as an isothermal reference for thermocouple measurements) 2 Frequency measurement channels
	DAQ464: 64 Channels (63 differential analog input channels, with channel 1 configured as an isothermal reference for thermocouple measurements) 2 Frequency measurement channels
Analog Inputs - Input range Common mode: Differential: Input protection: Input impedance:	±10.5 V standard ±10 V ±25 V continuous 22MΩ
Frequency Measurement Inputs Frequency Range: External Trigger:	2 single-ended TTL-level inputs that can be used as counters. Digital input 0 can also be used as an external trigger to start a scan 0.8 Hz to 50 kHz TTL-level low true pulse (1 second minimum pulse width)
Gain Range	1, 2, 4, 8, 16, 32, 64, 128 (software programmable on an individual channel basis)
Filters	Fixed single-pole RC, 100Hz cutoff (consult factory for other filter options)
Maximum Sampling Rate	4kHz
Sampling Rate Range	0.0625 Hz to 4 kHz
Resolution	16-bit, no missing codes
Noise (@ gain of 128)	9μV rms

DAQ400 Series Data Sheet continued.....

Item	Specification																													
Crosstalk	0.009% of OFF channel signal																													
I/O Connector Type	1 or 2 68-Position High Density SCSI (HONDA PCS-E68LMD) and 1 15-contact D subminiature connector																													
DC Power Requirements	<i>DAQ432</i> 10-18VDC (12VDC nominal), 8 watts <i>DAQ464</i> 10-18VDC (12VDC nominal), 9 watts																													
Accuracy	<table border="1"> <thead> <tr> <th data-bbox="500 412 553 437"><u>Gain</u></th> <th data-bbox="667 412 808 437"><u>Full-Scale Range (FSR)</u></th> <th data-bbox="927 412 1122 437"><u>Accuracy (%FSR)</u></th> </tr> </thead> <tbody> <tr> <td data-bbox="516 444 532 466">1</td> <td data-bbox="695 444 781 466">±10.000V</td> <td data-bbox="987 444 1057 466">0.020%</td> </tr> <tr> <td data-bbox="516 479 532 501">2</td> <td data-bbox="695 479 781 501">±5.000V</td> <td data-bbox="987 479 1057 501">0.020%</td> </tr> <tr> <td data-bbox="516 514 532 536">4</td> <td data-bbox="695 514 781 536">±2.500V</td> <td data-bbox="987 514 1057 536">0.030%</td> </tr> <tr> <td data-bbox="516 550 532 571">8</td> <td data-bbox="695 550 781 571">±1.250V</td> <td data-bbox="987 550 1057 571">0.030%</td> </tr> <tr> <td data-bbox="505 585 544 606">16</td> <td data-bbox="678 585 797 606">±625.000 mV</td> <td data-bbox="987 585 1057 606">0.040%</td> </tr> <tr> <td data-bbox="505 620 544 641">32</td> <td data-bbox="678 620 797 641">±312.500 mV</td> <td data-bbox="987 620 1057 641">0.040%</td> </tr> <tr> <td data-bbox="505 655 544 676">64</td> <td data-bbox="678 655 797 676">±156.250 mV</td> <td data-bbox="987 655 1057 676">0.050%</td> </tr> <tr> <td data-bbox="505 690 544 711">128</td> <td data-bbox="678 690 797 711">±78.125 mV</td> <td data-bbox="987 690 1057 711">0.065%</td> </tr> </tbody> </table>			<u>Gain</u>	<u>Full-Scale Range (FSR)</u>	<u>Accuracy (%FSR)</u>	1	±10.000V	0.020%	2	±5.000V	0.020%	4	±2.500V	0.030%	8	±1.250V	0.030%	16	±625.000 mV	0.040%	32	±312.500 mV	0.040%	64	±156.250 mV	0.050%	128	±78.125 mV	0.065%
<u>Gain</u>	<u>Full-Scale Range (FSR)</u>	<u>Accuracy (%FSR)</u>																												
1	±10.000V	0.020%																												
2	±5.000V	0.020%																												
4	±2.500V	0.030%																												
8	±1.250V	0.030%																												
16	±625.000 mV	0.040%																												
32	±312.500 mV	0.040%																												
64	±156.250 mV	0.050%																												
128	±78.125 mV	0.065%																												
Chassis Dimensions	<i>DAQ432</i> 57.5mm (2.26") high, 112mm (4.41") wide, 220mm (8.66") deep <i>DAQ464</i> 67.7mm (2.67") high, 112mm (4.41") wide, 220mm (8.66") deep																													
Weight	<i>DAQ432</i> 1.09kg (2.4lbs) <i>DAQ464</i> 1.13kg (2.5lbs)																													

Ordering Information

DAQ432-AA11 32-Channel Signal Conditioning Chassis with 16-Bit ADC

DAQ464-AA11 64-Channel Signal Conditioning Chassis with 16-Bit ADC

Related Products

DAQ750-464 Isothermal termination Assembly for the DAQ432 or DAQ464

5868-Bxyz 68-Position High Density SCSI to Unterminated Cable

DAQ-TRIG Push Button Cable Assembly for External Trigger

Model DAQ750-464 Isothermal Termination Assembly for the DAQ432 or DAQ464

Features

- Convenient termination of field wiring
- Up to 128 I/O terminations
- Internal Isothermal Reference for temperature measurements
- Field wiring terminations
- General-purpose temperature measurement

General Description

The DAQ750 is a termination assembly that mounts directly to the DAQ400 Series of Signal Conditioning Systems and provides terminals to receive field wiring. Each terminal accepts a single solid or stranded conductor in wire sizes AWG 26 to AWG 12. An isothermal reference is provided that may be used when terminating thermocouples to the assemblies. Signal connections between the DAQ750 and the DAQ400 Series front panel analog-in connector(s) are made with shielded, twisted pair cables.

DAQ750 Mounted
on DAQ464



DAQ400 Series – User Instructions

32/64 Channel Signal Conditioning Unit

Throughout this manual the DAQ432 and DAQ464 products will be referred to as DAQ, unless differences between the two options are being specified.

Unpacking

The DAQ system is shipped within a foam-packing container. Carefully remove the unit from its container. Included in the packing container along with the DAQ are the following items:

<u>Qty</u>	<u>Description</u>
1	2.5mm I.D., 5.5mm O.D. DC power plug with attached 2 meter un-terminated DC power cable
1	A/C to D/C Power supply with separate cord
1	15-contact D subminiature plug connector with backshell kit (solder cup termination)
1	CompactFlash™ memory card (256MB standard)
1	5' Crossover Ethernet cable
1	VersaDAQ Data Acquisition Software CD
1	DAQ400 Series Instruction Manual

Front Panel Information - LEDs

There are eight LEDs (light-emitting diodes) on the *DAQ* front panel that give visual indication of the operational status of the unit. The function associated with each LED is as follows:

Label	Function	Description
W	Write CompactFlash	Green LED is illuminated when CompactFlash™ memory is being written.
R	Read CompactFlash	Yellow LED is illuminated when CompactFlash™ memory is being read.
Act	ADC active	Green LED is illuminated when the <i>DAQ</i> ADC (analog-to-digital converter) is actively sampling data.
Rdy	Ready	Green LED will flash after power-up until the <i>DAQ</i> has completed its power-on diagnostic tests. The LED will then remain on indicating that the system is ready to be configured via the VersaDAQ software.
Arm	ADC Armed	Green LED is illuminated when the <i>DAQ</i> is armed and awaiting an external trigger signal to begin taking data. This LED will also flash three times approximately 18 seconds after the <i>DAQ</i> power is switched on.
Alm	Alarm	Not used.
Act, Connector A	ADC active	Green LED is illuminated when the <i>DAQ</i> ADC is actively sampling data.
Act, Connector B	ADC active	Green LED is illuminated when the <i>DAQ</i> ADC is actively sampling data. (<i>DAQ464</i> only.)

Reset Button

When depressed, the front panel reset button will reset the *DAQ* Ethernet IP address to the default address of 192.92.103.180. Reset also erases any stored configuration. To initiate a reset, depress and hold the reset button until the “Arm” LED begins flashing.

Connectors

Analog input signals are brought into the *DAQ* via the Connector A and Connector B 68-position high-density front panel connectors. Frequency Measurement channels, external trigger, and counter inputs are terminated to the 15-contact D subminiature front panel I/O connector. For a definition of the pins on these connectors refer to Figures 2 and 3 on the following pages.

Grounding and Shield Termination

It is highly recommended that the chassis of the *DAQ* be tied to ground (vehicle chassis ground for in-vehicle testing). A chassis ground screw is provided on the rear panel of the *DAQ*.

Analog Input Channels

There are 64 differential input analog channels that are configured at the factory with fixed single-pole filters. Input voltage ranges up to ± 10 volts are supported. The gain settings for the *DAQ* are user programmable through the *VersaDAQ* software. Provided gains are 1, 2, 4, 8, 16, 32, 64 and 128. The analog input channels have over-voltage protection.

Temperature Measurement

A DAQ system is supplied with channel 1 configured as an isothermal reference channel. This channel cannot be used for voltage or other input. Temperature measurement requires the use of a *DAQ750-464*, which has an on-board isothermal reference.

Frequency Measurement Channels

Two channels of single ended TTL-level inputs can be configured as frequency measurement channels. The range of frequency supported is 0.8 Hz to 50 kHz.

External Triggering

The DAQ can be configured via the *VersaDAQ* software to start acquiring data after receiving an external trigger pulse (TTL-level low true pulse, one-second minimum pulse width). An external push-button switch connected as shown in Figure 1 below can be used as a trigger source.

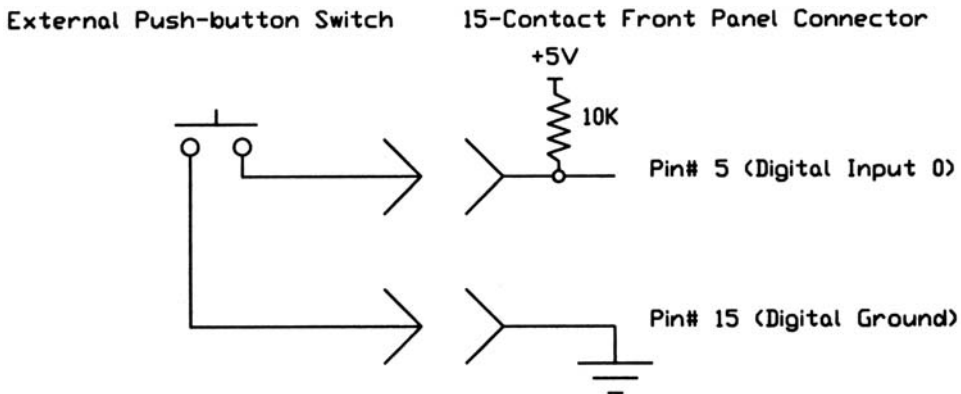

Page 16,
Figure 3

Figure 1. External Trigger Switch

Front Panel Connectors

Signals are connected to the input channels via the 68-position SCSI connectors on the *DAQ*. There is one connector for the *DAQ432* (labeled Connector A) and two connectors for the *DAQ464* (labeled Connector A and Connector B).

The *DAQ432* model has all 32 channels on Connector A, while the *DAQ464* has odd channels on Connector A and even channels on Connector B. Connections may be made via the *DAQ750-464* Termination Panel, or two 68-position SCSI cables (only one needed for *DAQ432*), part number 5868-Bxyz. The 5868-Bxyz cables are unterminated at one end for field wiring.

When using the *DAQ464-750*, the inputs to the front panel connectors will be via the attached cables. In that case, inputs should screw into the terminal strips. The plastic cover on the top of the *DAQ750-464* will indicate the locations of each channel's differential input.

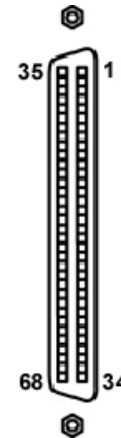

**Figure 2. Front Panel Connectors
Connector A and Connector B**

Pin	Description
1	Ch 1 + (Pos)
2	Ch 3 + (Pos)
3	Ch 5 + (Pos)
4	Ch 7 + (Pos)
5	Ch 9 + (Pos)
6	Ch 11 + (Pos)
7	Ch 13 + (Pos)
8	Ch 15 + (Pos)
9	Ch 17 + (Pos)
10	Ch 19 + (Pos)
11	Ch 21 + (Pos)
12	Ch 23 + (Pos)
13	Ch 25 + (Pos)
14	Ch 27 + (Pos)
15	Ch 29 + (Pos)
16	Ch 31 + (Pos)
17	Ch 33 + (Pos)

Pin	Description
18	Ch 35 + (Pos)
19	Ch 37 + (Pos)
20	Ch 39 + (Pos)
21	Ch 41 + (Pos)
22	Ch 43 + (Pos)
23	Ch 45 + (Pos)
24	Ch 47 + (Pos)
25	Ch 49 + (Pos)
26	Ch 51 + (Pos)
27	Ch 53 + (Pos)
28	Ch 55 + (Pos)
29	Ch 57 + (Pos)
30	Ch 59 + (Pos)
31	Ch 61 + (Pos)
32	Ch 63 + (Pos)
33	Reserved *
34	Ground

Pin	Description
35	Ch 1 - (Neg)
36	Ch 3 - (Neg)
37	Ch 5 - (Neg)
38	Ch 7 - (Neg)
39	Ch 9 - (Neg)
40	Ch 11 - (Neg)
41	Ch 13 - (Neg)
42	Ch 15 - (Neg)
43	Ch 17 - (Neg)
44	Ch 19 - (Neg)
45	Ch 21 - (Neg)
46	Ch 23 - (Neg)
47	Ch 25 - (Neg)
48	Ch 27 - (Neg)
49	Ch 29 - (Neg)
50	Ch 31 - (Neg)
51	Ch 33 + (Neg)

Pin	Description
52	Ch 35 + (Neg)
53	Ch 37 + (Neg)
54	Ch 39 + (Neg)
55	Ch 41 + (Neg)
56	Ch 43 + (Neg)
57	Ch 45 + (Neg)
58	Ch 47 + (Neg)
59	Ch 49 + (Neg)
60	Ch 51 + (Neg)
61	Ch 53 + (Neg)
62	Ch 55 + (Neg)
63	Ch 57 + (Neg)
64	Ch 59 + (Neg)
65	Ch 61 + (Neg)
66	Ch 63 + (Neg)
67	Reserved *
68	Ground

* Pins 33 and 67 are reserved. Do not use.

Table 1. 68-Position High Density Connector A Pinout, DAQ464 Model

Pin	Description
1	Ch 2 + (Pos)
2	Ch 4 + (Pos)
3	Ch 6 + (Pos)
4	Ch 8 + (Pos)
5	Ch 10 + (Pos)
6	Ch 12 + (Pos)
7	Ch 14 + (Pos)
8	Ch 16 + (Pos)
9	Ch 18 + (Pos)
10	Ch 20 + (Pos)
11	Ch 22 + (Pos)
12	Ch 24 + (Pos)
13	Ch 26 + (Pos)
14	Ch 28 + (Pos)
15	Ch 30 + (Pos)
16	Ch 32 + (Pos)
17	Ch 34 + (Pos)

Pin	Description
18	Ch 36 + (Pos)
19	Ch 38 + (Pos)
20	Ch 40 + (Pos)
21	Ch 42 + (Pos)
22	Ch 44 + (Pos)
23	Ch 46 + (Pos)
24	Ch 48 + (Pos)
25	Ch 50 + (Pos)
26	Ch 52 + (Pos)
27	Ch 54 + (Pos)
28	Ch 56 + (Pos)
29	Ch 58 + (Pos)
30	Ch 60 + (Pos)
31	Ch 62 + (Pos)
32	Ch 64 + (Pos)
33	Reserved *
34	Ground

Pin	Description
35	Ch 2 - (Neg)
36	Ch 4 - (Neg)
37	Ch 6 - (Neg)
38	Ch 8 - (Neg)
39	Ch 10 - (Neg)
40	Ch 12 - (Neg)
41	Ch 14 - (Neg)
42	Ch 16 - (Neg)
43	Ch 18 - (Neg)
44	Ch 20 - (Neg)
45	Ch 22 - (Neg)
46	Ch 24 - (Neg)
47	Ch 26 - (Neg)
48	Ch 28 - (Neg)
49	Ch 30 - (Neg)
50	Ch 32 - (Neg)
51	Ch 34 + (Neg)

Pin	Description
52	Ch 36 + (Neg)
53	Ch 38 + (Neg)
54	Ch 40 + (Neg)
55	Ch 42 + (Neg)
56	Ch 44 + (Neg)
57	Ch 46 + (Neg)
58	Ch 48 + (Neg)
59	Ch 50 + (Neg)
60	Ch 52 + (Neg)
61	Ch 54 + (Neg)
62	Ch 56 + (Neg)
63	Ch 58 + (Neg)
64	Ch 60 + (Neg)
65	Ch 62 + (Neg)
66	Ch 64 + (Neg)
67	Reserved *
68	Ground

* Pins 33 and 67 are reserved. Do not use.

Table 2. 68-Position High Density Connector B Pinout, DAQ464 Model

Pin	Description
1	Ch 1 + (Pos)
2	Ch 2 + (Pos)
3	Ch 3 + (Pos)
4	Ch 4 + (Pos)
5	Ch 5 + (Pos)
6	Ch 6 + (Pos)
7	Ch 7 + (Pos)
8	Ch 8 + (Pos)
9	Ch 9 + (Pos)
10	Ch 10 + (Pos)
11	Ch 11 + (Pos)
12	Ch 12 + (Pos)
13	Ch 13 + (Pos)
14	Ch 14 + (Pos)
15	Ch 15 + (Pos)
16	Ch 16 + (Pos)
17	Ch 17 + (Pos)

Pin	Description
18	Ch 18 + (Pos)
19	Ch 19 + (Pos)
20	Ch 20 + (Pos)
21	Ch 21 + (Pos)
22	Ch 22 + (Pos)
23	Ch 23 + (Pos)
24	Ch 24 + (Pos)
25	Ch 25 + (Pos)
26	Ch 26 + (Pos)
27	Ch 27 + (Pos)
28	Ch 28 + (Pos)
29	Ch 29 + (Pos)
30	Ch 30 + (Pos)
31	Ch 31 + (Pos)
32	Ch 32 + (Pos)
33	Reserved *
34	Ground

Pin	Description
35	Ch 1 - (Neg)
36	Ch 2 - (Neg)
37	Ch 3 - (Neg)
38	Ch 4 - (Neg)
39	Ch 5 - (Neg)
40	Ch 6 - (Neg)
41	Ch 7 - (Neg)
42	Ch 8 - (Neg)
43	Ch 9 - (Neg)
44	Ch 10 - (Neg)
45	Ch 11 - (Neg)
46	Ch 12 - (Neg)
47	Ch 13 - (Neg)
48	Ch 14 - (Neg)
49	Ch 15 - (Neg)
50	Ch 16 - (Neg)
51	Ch 17 - (Neg)

Pin	Description
52	Ch 18 - (Neg)
53	Ch 19 - (Neg)
54	Ch 20 - (Neg)
55	Ch 21 - (Neg)
56	Ch 22 - (Neg)
57	Ch 23 - (Neg)
58	Ch 24 - (Neg)
59	Ch 25 - (Neg)
60	Ch 26 - (Neg)
61	Ch 27 - (Neg)
62	Ch 28 - (Neg)
63	Ch 29 - (Neg)
64	Ch 30 - (Neg)
65	Ch 31 - (Neg)
66	Ch 32 - (Neg)
67	Reserved *
68	Ground

* Pins 33 and 67 are reserved. Do not use.

Table 3. 68-Position High Density Connector A Pinout, DAQ432 Model

Pin	Description
1	Reserved
2	Reserved
3	Reserved
4	Digital / Frequency Input 1
5	External Trigger / Frequency Input 0
6	Reserved
7	Reserved
8	Reserved
9	Not Used
10	Not Used
11	Not Used
12	Not Used
13	Digital Ground
14	Digital Ground
15	Digital Ground

**Table 4. 15-Contact Front Panel Connector
(Digital I/O Connections)**

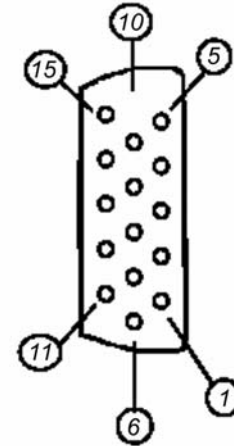

**Figure 3. 15-Contact D
Subminiature Front Panel
Connector**

Hardware Setup

1. Insert the CompactFlash™ memory card into the *DAQ* front panel CompactFlash™ slot. The CompactFlash™ card has a wide groove on the top and a narrow groove on the bottom. Make sure the card is oriented properly and do not force it into the slot. **Power must be turned off when installing or removing the CompactFlash™ memory card.**
2. Connect the unterminated end of the DC power input cable to a stable DC power source of 10-18 volts (12 volts nominal). Otherwise connect the A/C to D/C power supply to the unit.
3. If Ethernet connectivity is needed, connect the 10 BaseT Ethernet port on the *DAQ* front panel to a host computer. **The Ethernet port must be connected before power to the *DAQ* is switched on.**
4. After all hardware connections have been made, move the power switch located on the rear panel of the *DAQ*, to the “ON” position. The *DAQ* will run a series of diagnostic tests after switching on power that will take approximately 20 seconds to complete. The “Rdy” LED on the system front panel will flash until completion of these tests, then remain on, indicating that the system is ready to be configured via the *VersaDAQ* software.

VersaDAQ Software

VersaDAQ allows the user to quickly and easily control all aspects of data acquisition, from individual channel properties to the overall sample rate of the entire system. *VersaDAQ* is built on Sun Microsystem's *Java** technology, allowing it to package a state-of-the-art Graphical User Interface (GUI) in a fully cross platform software application.

*Java® is a trademark of Sun Microsystems.

Getting Started

VersaDAQ is an application that allows the user to manage data acquisition session *Configurations*. A configuration is all the settings under which the data acquisition will be made - channel gains, filtering, sample rate, the conditions under which the session will start and stop, etc.

With *VersaDAQ*, the user can create, modify, and update configurations, and then save or load them locally on their computer system or on the *DAQ* system itself.

Importing and Exporting Configuration Settings

Configuration settings are transported to and from the *DAQ* by the File|Export and File|Import operations, respectively. The configuration information is actually communicated to and from the *DAQ* by 1 of 2 means: via an Ethernet (TCP/IP) connection, or via the CompactFlash™ card. The selection between these 2 mechanisms is controlled via the Edit|Configuration Target Dialog.

Configuring the DAQ via Ethernet Connection

When Ethernet is chosen, *VersaDAQ* imports and exports by opening a TCP/IP connection to the *DAQ*. In order for this connection to be successful, the physical connections between the host computer and the *DAQ* must be configured properly:

- **Plug in Ethernet cables before powering on.** It is necessary that *all* Ethernet cable connections be made *before* the *DAQ* is powered on, either directly to the PC or to a hub (see details below). If the *DAQ* is powered on before the Ethernet cables are plugged together, it will not be possible to connect. Power the *DAQ* down, attach necessary cables, and power the *DAQ* back up.
- **Use correct type of Ethernet cable.** In general, there are two options for interconnecting the computer running *VersaDAQ* and the *DAQ*: direct (peer to peer) and networked. The figure below illustrates the two possibilities.

In Figure 4(a), the PC's Ethernet outlet on the network card is connected directly to the Ethernet outlet on the *DAQ*. This configuration requires a special *crossover* or *peer-to-peer* Ethernet cable; a standard Ethernet cable will not work.

In Figure 4(b and c), the PC and the *DAQ* are both plugged into Ethernet hubs, either the same hub -- as in (b) -- or in different hubs belonging to the same network -- as in (c). In such a situation, a standard Ethernet cable is required.

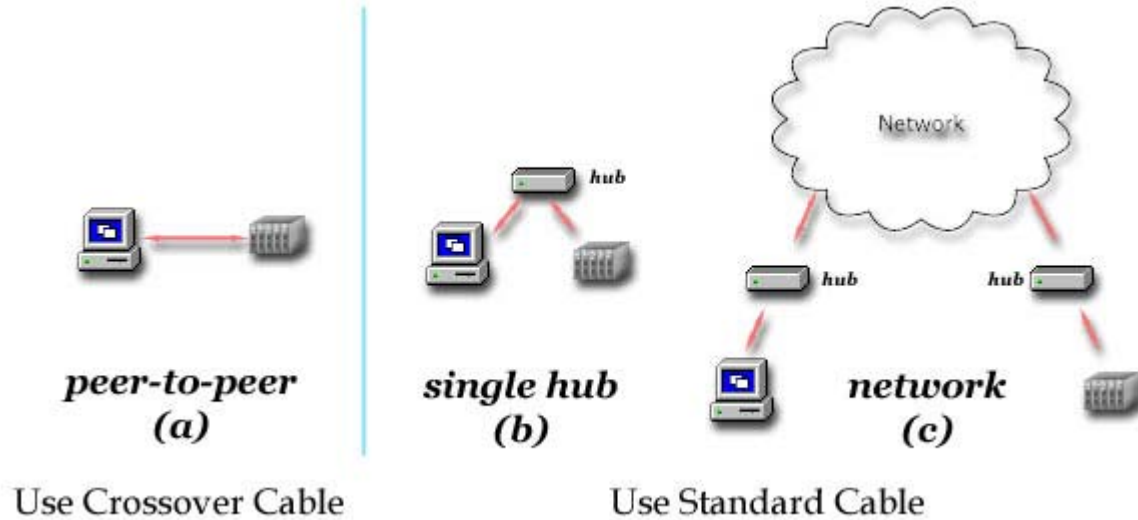

Figure 4. Connecting the DAQ to the Ethernet

Configuring the IP Address

In addition to the physical cabling, certain settings must be coordinated between *VersaDAQ* and the *DAQ*. *VersaDAQ* communicates with the *DAQ* over an Ethernet connection using the *DAQ*'s IP Address.

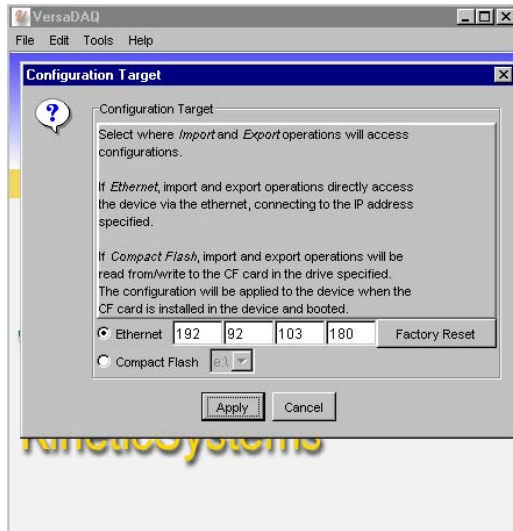

Figure 5. Configuration Target Dialog

The IP address, which *VersaDAQ* uses to communicate to the *DAQ*, must match exactly the IP address that the *DAQ* responds to. When *VersaDAQ* is first installed, the software is configured with the IP address that the *DAQ* is set to at the factory, 192.92.103.180.

The IP address used by *VersaDAQ* can be modified via the Configuration Target Dialog. The IP address the device responds to can be modified via the Device Settings Dialog. Changing the IP address here can also -- at the user's discretion -- update the IP address *VersaDAQ* uses as well, so that both the *DAQ* and *VersaDAQ* move to a new IP address in tandem.

The IP address the *DAQ* answers to can also be reset to its factory default by pressing and holding the reset button on the *DAQ*'s front panel until the *DAQ*'s 'Arm' LED flashes. This forces the *DAQ* to come up in a clean state, its IP address set back to the factory default.

The Edit|Configuration Target Dialog (Figure 5) is used to specify the IP address that *VersaDAQ* will use when attempting to connect to the *DAQ*. This IP address must match exactly the IP address that the *DAQ* is set to (described below). Select the 'Ethernet' radio button and enter the IP address of the *DAQ*. The 'Factory Reset' button will set the IP address boxes to the *DAQ*'s factory default setting (the IP address the *DAQ* reverts to when the reset button is pushed). Click the 'Apply' button for the change to take effect.

Configuring the IP Address continued

The Edit|Device Settings Dialog (Figure 6) selects the IP address the DAQ responds to. This IP address should match exactly the IP address specified in the Edit|Configuration Target Dialog.

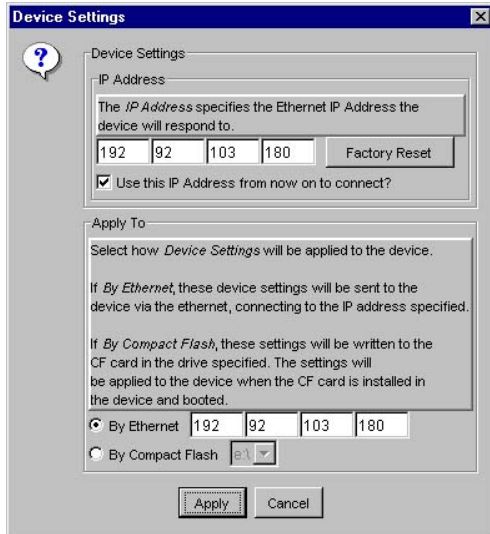

Figure 6. Device Settings Dialog

Once the IP address is specified, VersaDAQ must transmit this new IP address information to the DAQ. The 'Apply To' section on the dialog specifies how the IP address is transmitted to the DAQ: either via Ethernet or CompactFlash™. If by Ethernet, a TCP/IP connection is opened using the IP address specified by the IP address immediately to the right of the 'By Ethernet' radio button, and the data is written directly to the DAQ. *Note that this is only possible if an Ethernet connection has already been successfully established between VersaDAQ and the DAQ; the IP address in the 'Apply To' section is the current IP address of the DAQ, and the IP address in the 'Device Settings' section is the IP address that the DAQ will respond to after the change takes effect. If the DAQ's IP address must be modified in order for it to be reachable and it is not possible to connect to it via Ethernet. In this case, 'By Compact Flash' should be selected in the 'Apply To' section, as explained below.*

Alternatively, the IP address of the DAQ can be modified by applying the change to a CompactFlash™ card mounted in a drive on the host computer, and then inserting that CompactFlash™ card into the DAQ; when the DAQ boots. It will find the specified IP address on the CompactFlash™ card and *override* its current setting and will answer to the IP address on the CompactFlash™ card. *If the CompactFlash™ card is subsequently removed, the DAQ will revert to its own internal IP address the next time it powers up.*

To write an IP address on a CompactFlash™ card, choose the Edit|Device Settings Dialog (again, Figure 6), set the IP address in the Device Settings section to the IP address the DAQ should respond to, choose 'By Compact Flash' in the 'Apply To' section, choose the system drive the CompactFlash™ card is mounted on, and click the Apply button. When the CompactFlash™ card is inserted into the DAQ, it will boot to that IP address.

Configuring the DAQ via CompactFlash

Configuration information can also be communicated to the DAQ via CompactFlash. In this case, the 'Compact Flash' radio button of Figure 7 should be selected, as well as the system drive the CompactFlash™ card is mounted on.

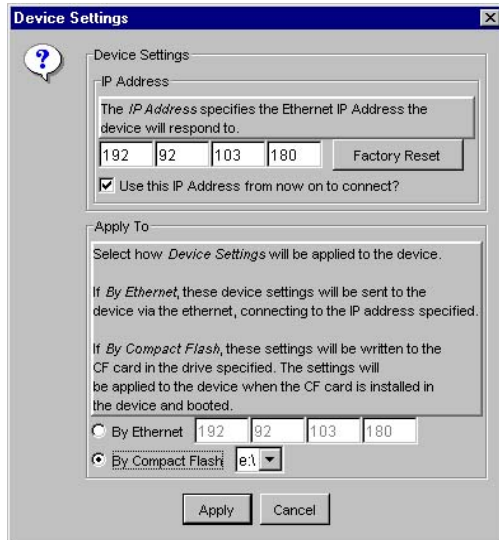

Figure 7. Device Settings Dialog

Subsequent File|Export and File|Import operations will send and load a configuration to/from the CompactFlash™ in the specified system drive. When a CompactFlash™ card that has had a configuration exported to it is placed in the DAQ, the DAQ will boot into that configuration. Using this mode, it is possible to configure the DAQ without having to ever connect to it.

Configuring the Local Computer for Peer-to-peer Connections



Figure 8. Local Area Connection

In a peer-to-peer configuration, the network number of host and *DAQ* must match. IP addresses are traditionally presented as 4 3-digit numbers separated by periods. The first 3 numbers are the network number, and the 4th number is the host number. In a peer-to-peer configuration (see Figure 7 above), the network number of the host computer and the network number of the *DAQ* must match. Therefore, it may be necessary to change the host computer's network number to match the network number of the *DAQ* for connecting without changing the *DAQ*'s IP address.

Looking at figure 7, the current IP address of *VersaDAQ* and the *DAQ* is 192.92.103.180. The PC's IP address must be configured for operation on the same network (192.92.103). A good choice for the PC's IP address might be 192.92.103.181.

Changing the PC's IP address will vary depending on the Operating System. Under Windows, this will typically mean going to the Start button, and choosing Settings/Control Panel/Network. This may have to be refined by specifying 'Local Area Connection' as opposed to "Make New Connection". The example screen shots (Figures 8, 9 and 10) are taken from this procedure made on a Windows 2000 computer.

Configuring the Local Computer for Peer-to-peer Connections, continued

Click the 'Properties' button and another window will pop up. (See Figure 9.) Click on 'Internet Protocol (TCP/IP)' and then "Properties" button. This will bring up the window with the IP address. (Figure 10.)



Figure 9. Local Area Connection Properties

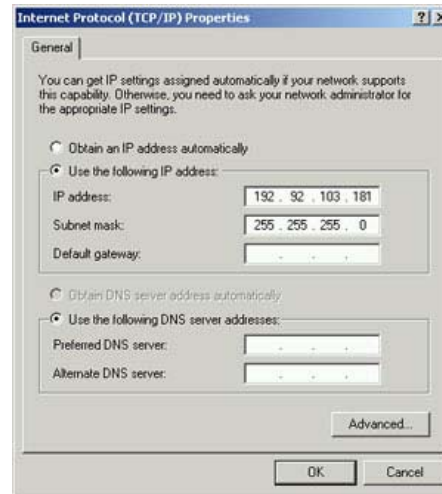

Figure 10. TCP/IP Properties

Configuring the Local Computer for Peer-to-peer Connections, continued

Make sure the "Use the following IP address" button is selected, enter the desired IP address (192.92.103.181, in this example), and a "Subnet Mask" of 255.255.255.0. Click "OK", and the procedure is done. On some versions of Windows, you may need to reboot the PC before the change takes effect.

Creating a Configuration

Using the File pull-down menu, choose the 'New' option. This will open a new default configuration and open the configuration window in the application. A default configuration is built upon the defaults for the hardware type selected in the Edit|Configuration Type Dialog. The configuration type must match the hardware for which the configuration is being built. Defaults include all channels enabled and set to their default state (gain is 1, sensor type is voltage, EU is volts). The sample rate is set to 100 Hz.

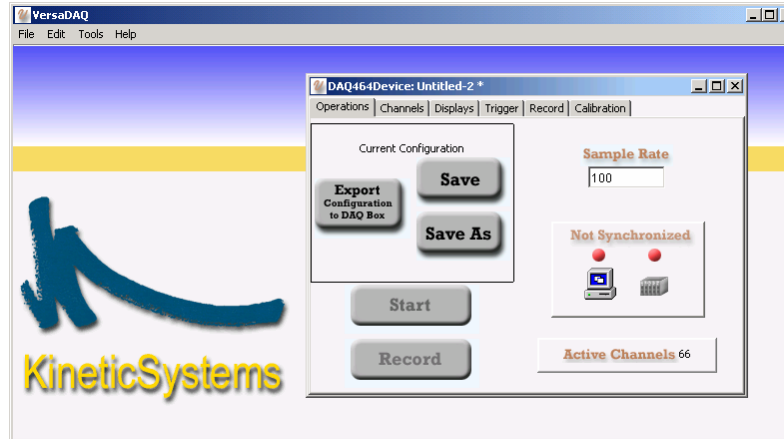

Figure 11. New Configuration

Operations Tab

The Operations Tab is the main control in *VersaDAQ*. The Operations Tab is for programming and controlling the data acquisition system.

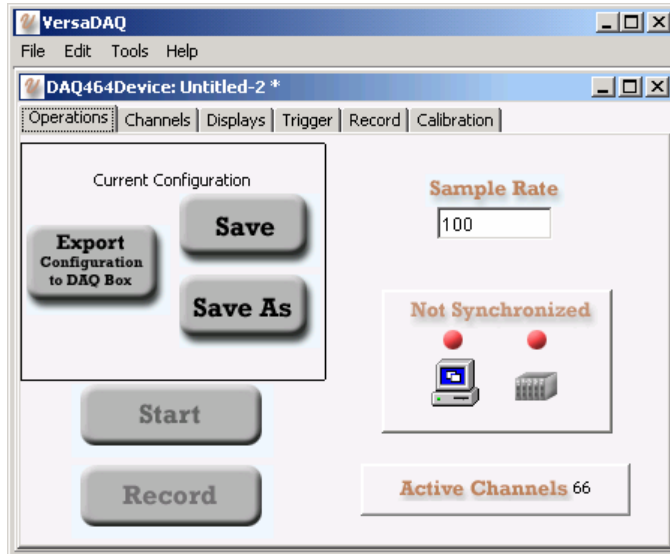

Figure 12. Operations Tab

This screen gives the ability to export (send to the DAQ) and save configurations to the computer. The Export operation takes the current configuration and sends it to the DAQ. The DAQ will now run according to the parameters of the configuration. As a configuration is being edited in the *VersaDAQ* application, the changes made are visible only to *VersaDAQ*; they will not take effect on the DAQ until the Export operation is performed.

This screen also provides the mechanism to start acquisition, stop acquisition, record the data and set the sample rate.

This screen indicates when the configuration is synchronized to the DAQ unit. (See next section for explanation.) It also indicates the number of Active Channels.

The start/record buttons are disabled (grayed-out) until the DAQ is synchronized to *VersaDAQ*.

Synchronization

The 'Synchronized' indicator on the Operations Tab shows the synchronization status. The Export operation changes the synchronization status from 'Not Synchronized' to 'Synchronized', after a successful Export operation. *VersaDAQ* will not allow hardware operations (start an acquisition, arm the external trigger, etc.) until the configuration is synchronized.

It is important to understand that any subsequent changes to the configuration will automatically change the Synchronization status back to 'Not Synchronized'. This merely indicates that *VersaDAQ*'s version of the configuration is mismatched from the DAQ's. Another File/Export operation will re-export the newly updated version of the configuration down to the hardware, and the two will again be 'Synchronized'.

Channels Tab

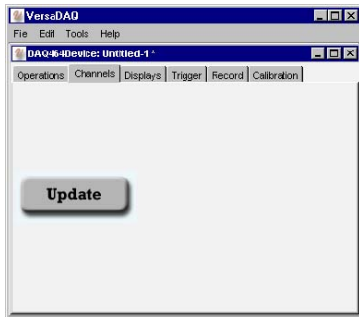

The following buttons are available on the panel:

- Update Button

The Update Button allows the user to modify channel properties (Gain, Sensor Type, etc.). Upon pushing this button, the user will first be presented with the Channel Chooser Dialog to select which channel(s) will be modified. Next, the user will be presented with the Channel Properties Dialog, which contains various selectors for modifying channel properties.

Figure 13. Channels Tab

Selecting Channels to Modify

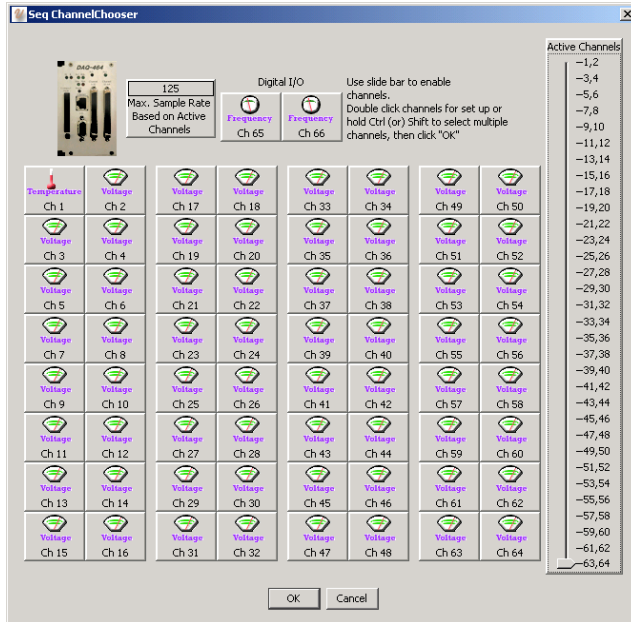

Figure 14. Sequential Channel Chooser

This dialog allows for selecting which channel or channels to modify.

The slide bar to the right is used to enable and disable channels in groups of two channels at a time. Disabled channels are grayed-out.

For the convenience of the user, the maximum attainable sample rate based on the number of active channels is displayed on this screen.

Double clicking a channel will bring up a new dialog box that allows the user to define channel properties.

Tip – Holding the shift or alt key will enable the user to select multiple channels at one time. This saves set up time if configuring more than one channel to the same setting.

Select the channels then click OK.

Channel Properties

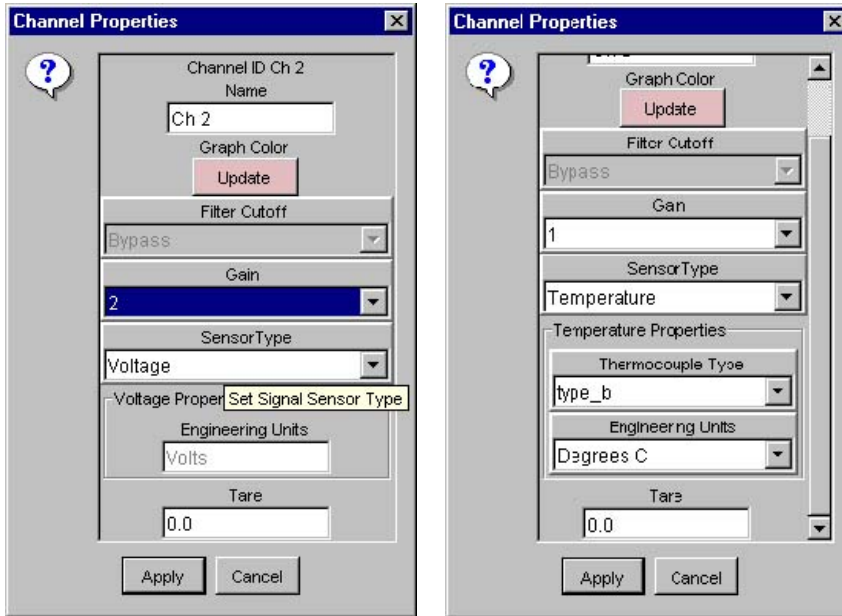

Figure 15. Channel Properties Dialogs

By double clicking a channel on the Channel Chooser screen, the Channel Properties Dialog box below becomes active.

Properties that can be modified include channel name, graph color, gain, filter (for those DAQ options that support programmable filter), sensor type, engineering units, and tare.

Some sensor types, when chosen, will expand the Channel Properties screen to include additional properties. For instance, when selecting 'Temperature' as the sensor type, the additional channel properties 'Thermocouple Type' and 'Engineering Units' become available, each with its own pull-down menu.

Selecting 'Apply' will save the Channel Properties for the channel or channels.

Display Tab

Under the Display Tab users can configure, by checking the appropriate check boxes, which real time displays to activate. Multiple channels can be selected for the digital or graph displays by holding the ctrl or shift button clicking on the channels. Once a graph or display is selected, the user will then be able to name the display.

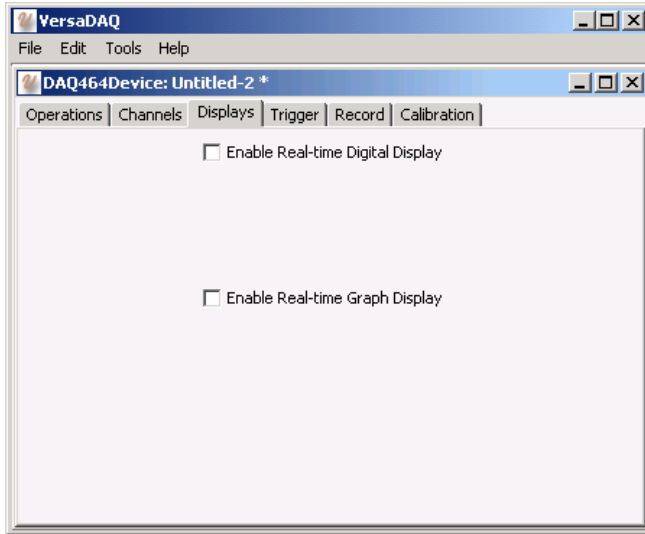

Figure 16. Selecting Real-time Displays

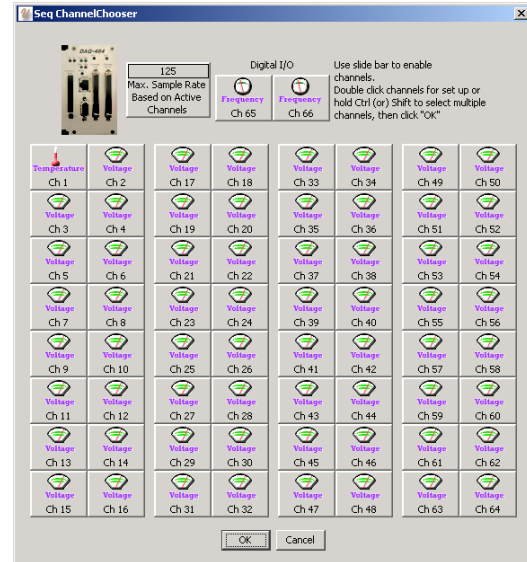

Figure 17. Sequential Channel Chooser

Real Time Displays

The user can change or create displays by selecting Edit/New or Edit/Modify within the real-time graph or digital display window by right clicking on a graph. The user can also adjust the color or scaling of the data being viewed. The VersaDAQ online help explains in detail.

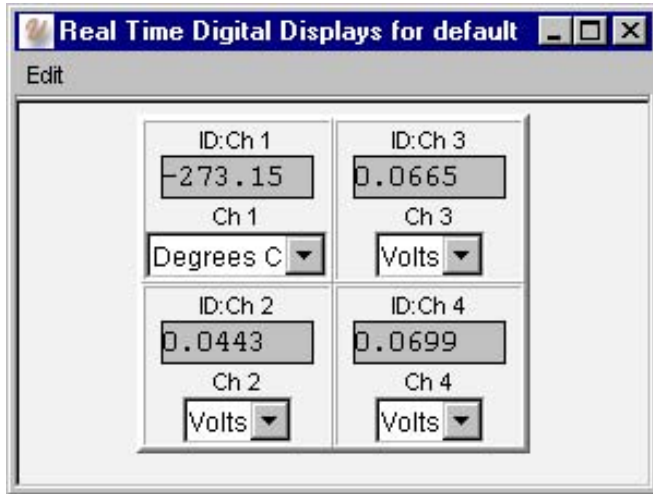

Figure 18. Real-time Digital Display

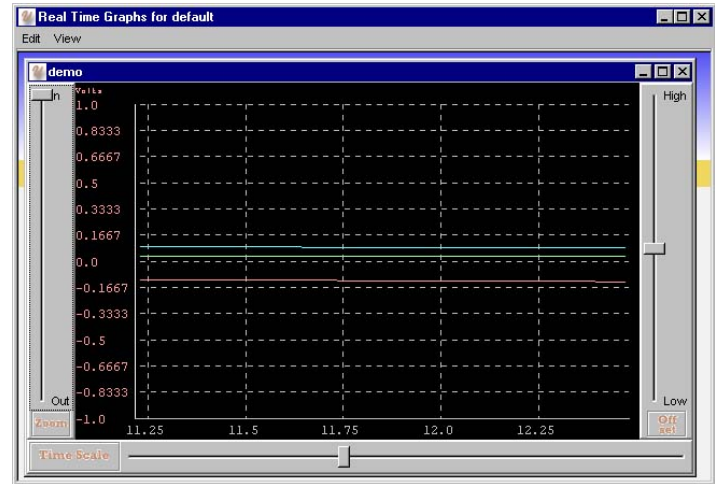

Figure 19. Real-time Graph Display

Trigger Tab

The Trigger Mode specifies what event will trigger the start of the data acquisition.

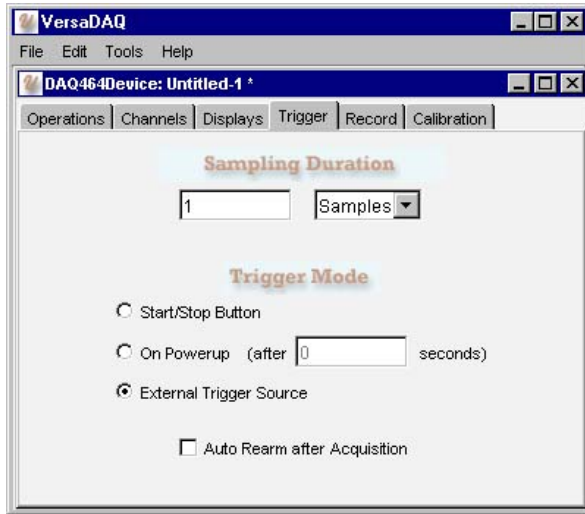

Figure 20. Trigger Tab

The Sampling Duration specifies the amount of data that will be collected, expressed in terms of total samples or time (seconds) elapsed. Sampling Duration is disabled and defaulted to '(N/A)' unless the Trigger Mode is set to 'External Trigger Source' or 'On Powerup'. In these cases, the numeric edit box and unit pull-down are enabled.

- When the mode is set to 'Start/Stop Button', control of the acquisition is under manual control of the user via the Start/Stop button on the Operations Tab.
- When the mode is set to 'On Powerup', acquisition will occur automatically, a specified number of seconds after the DAQ powers up.
- Once the acquisition starts, it will collect the number of samples specified by the Sampling Duration, and then terminate.
- When the mode is set to 'External Trigger Source', acquisition will be triggered by an external signal fed into the DAQ.
- In order for this external signal to be recognized, the system must also be armed. Arming and disarming the system is controlled by the Arm/Disarm Button on the Operations Tab. This button is only available when the mode is set to 'External Trigger Source'.
- Once triggered acquisition begins, it will collect the number of samples specified by the Sampling Duration, and then terminate the acquisition.

Record Tab

The Record Tab allows users to specify how the DAQ will initiate recording functions as well as if the user will record to a local computer or to CompactFlash™ in stand-alone applications.

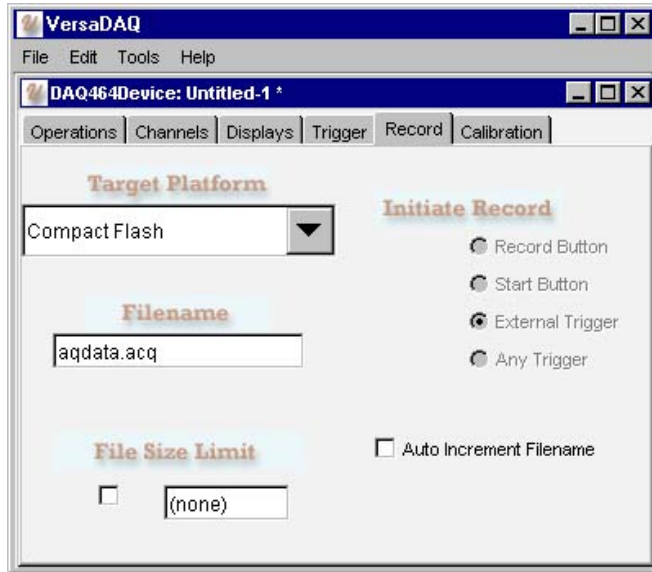

Figure 21. Record Tab

This screen also lets users determine file names, file size limits and if there needs to be Auto Increment Filenames in situations where the DAQ will be recording repeated tests.

The Target Platform control selects the location the data will be collected on. The options include Local (the host PC) or CompactFlash™.

The Filename control determines the filename on the Target Platform under which the data will be stored. The name may be simple, or it may be a complete pathname, depending on the nature of the Target Platform. If the name can include a full pathname (such as if the Target Platform were the Local host PC), there will be a Browse Button that will bring up a standard file dialog box.

Record Tab, continued

The Initiate Record control selects the conditions under which the recording of data will begin. **Do not** confuse the start of data acquisition with the start of data recording. Data recording will start at some point in time at or after the acquisition starts, and will terminate at some point at or before the acquisition ends.

This control has several options:

- Record Button - when this option is set, the Record Button on the Operations Panel is enabled whenever data acquisition is running (i.e., the Start Button is clicked). Recording will begin when the user clicks the Record Button and will terminate when the user clicks the Stop Recording Button (or the data acquisition stops).
- Start Button - when this option is set, data recording will automatically begin when the data acquisition starts (i.e., the Start Button is clicked), and terminates when the acquisition stops (i.e., the Stop Button is clicked).
- External Trigger - when this option is set, data recording will automatically begin when the data acquisition starts via an external trigger event Please see the Trigger Mode control on the Trigger Panel for more information on the external trigger.
- Any Trigger - when this option is set, data recording will begin automatically whenever data acquisition begins, regardless of what caused the acquisition to begin.

Some of the Initiate Record options may be disabled, based on the setting of other controls. For example, if the Trigger Mode is set to "External Trigger Event", Initiate Record must be set to either "External Trigger" or "Any Trigger". This is because under the external trigger mode, the data acquisition system is assumed to be in stand alone mode (i.e., not connected to the host PC), and therefore the only thing it can do is record data.

Record Tab, continued

The File Size Limit control allows the user to optionally limit the size of the collected data file to some byte size. If a limit is desired, the check box should be checked, and a byte count limit entered in the box. While data recording is taking place, if there is a limit specified and the file exceeds this limit, data recording will terminate (the data acquisition itself is unaffected).

Note: Setting a file size limit too small can cause an unexpected termination of data recording and a loss of collected data.

Other settings in the configuration may impose a required File Size Limit. Use of certain limited resources such as flash media for the Target Platform may set the limit to a certain size.

By default, each time a data file is opened to record data, any previous file under that name is lost. When the Auto Increment Filename box is checked, data is saved in the file with an incrementing index appended to the filename (e.g. *file1*, *file2*, ..., *filen*). Each time a recording session starts, the index is incremented and a new file is created.

Note: When data is recorded on the DAQ, the file length limit of 8 characters is in effect. The index appended onto the given filename may exceed this 8-character limit. When this happens, the filename is right truncated to provide space for the index.

Note: For VersaDaq version 1.4.1.0 and later, data recorded either locally (to host PC) or to Compact Flash will be the same format, aqdata.acq. If data is to be viewed via the KineticSystems Viewer, it will first need to be converted by the converter tool, which is explained in the “Viewing Recorded Data” section.

Start Data Acquisition

After the Export operation is performed and the configuration is synchronized, the 'Start' button will become active (active buttons have a pop-out appearance, and are highlighted when the mouse moves over them). When the Start button is clicked, the data acquisition hardware will begin sampling data, according to the configuration settings that were exported. If real-time graphs are defined, the output of these data channels will be viewable. After the Start button is clicked, it changes to a Stop button. In general, VersaDAQ controls such as buttons are labeled as to what will happen if the button is clicked. Clicking the Stop button will stop the data acquisition.

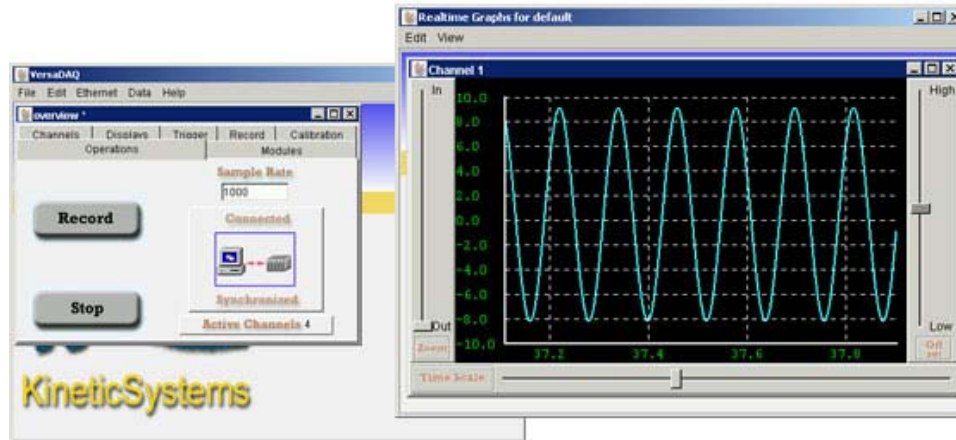

Figure 22. Data Acquisition in Progress

Viewing Recorded Data

Once recording has stopped, the KineticSystems Viewer can be used to examine the data that was recorded. On the Data pull-down menu, select 'Viewer'.

The KineticSystems Viewer runs as another application in a different window. It automatically brings up its open file dialog.

Features of the Viewer include:

- Zooming of X-Axis (Time)
- Zooming of Y-Axis (Voltage)
- Multiple View Windows
- Ability to Enter a Start/Stop Viewing Range
- Easy to use Y-Scale scroll bar
- Configurable Graph Colors

Use of the Viewer is completely documented in the Viewer's on-line help.

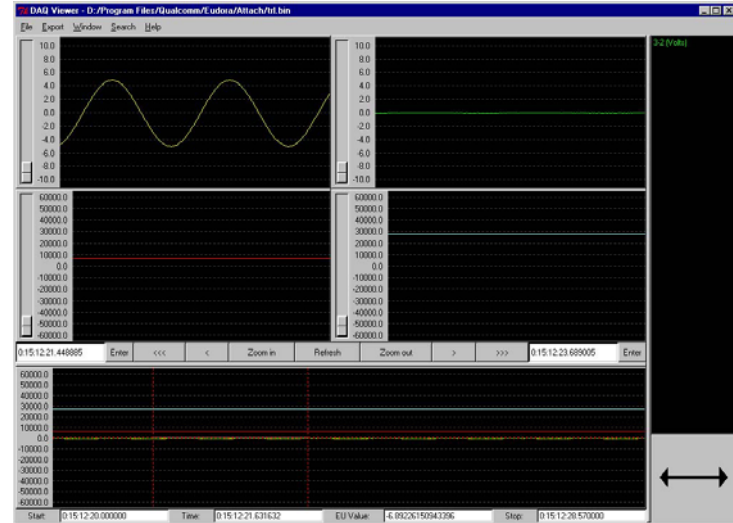

Figure 23. KineticSystems Viewer

Data Converter Tool

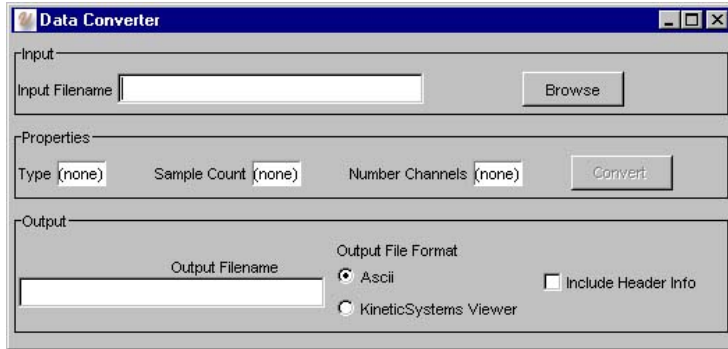

Figure 24. Data Converter Tool

The Output File Format can be set to the following:

- **Ascii** - data will be converted to a tab-delimited ascii file, suitable for importing into applications such as Microsoft Excel. Header information (channel names, number of samples, etc.) are optionally included via a checkbox. The file suffix is '.tda' - tab delineated ascii.
- **KineticSystems Viewer** - data will be converted into a file format suitable for the KineticSystems Viewer. The file suffix will be '.bin' - binary data.

VersaDAQ's Converter Tool performs conversion of acquired data from one format type into another. The input file is not modified in any way.

The following procedure outlines how the tool is used:

Step 1: Specify the Input Filename

Enter the filename to convert in the Input Filename text box; alternately, use the 'Browse' button to bring up a standard file dialog to identify the file to be converted.

Step 2: Verify Properties of the Input File

After the Input filename is specified, it is opened and its type, number of samples, and number of channels, is specified. This information is provided as a convenience.

Step 3: Specify the Output Filename and file format

When the Input Filename was specified in Step 1, the Output Filename was defaulted to the same name and same location (its file suffix will be different). A new name and path can be specified in the Output Filename if desired.

Step 4: Click the 'Convert' Button

The output file is created and the data is ready to be imported to another application.

EU Calibration Tool

This tool allows the user to enter multi-point calibration information. Multi-point calibration transforms raw data from a sensor to a final result in appropriate units according to a *curve* specified. The curve is expressed as a finite set of points, entered into the EU Calibration by the user.

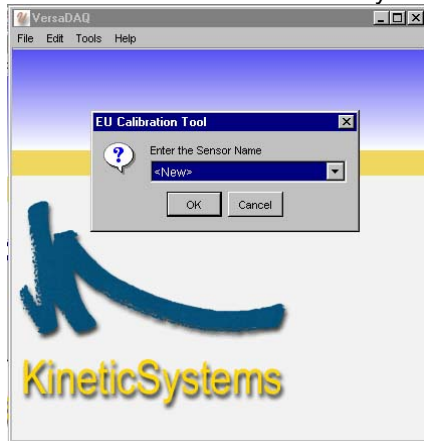

Figure 25. Choose a Sensor Name



Figure 26. Enter New Sensor Name

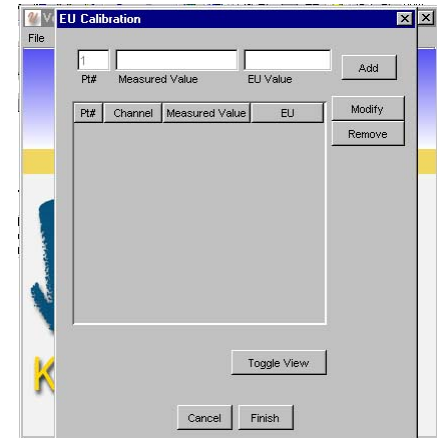

Figure 27. Enter Calibration Points

First, a name of the transformation is required; a previously created transformation can be chosen, or **<New>** can be chosen to create a new transformation. (Figure 25) After choosing **<New>** and clicking the OK button, a dialog is presented to enter the name of the new transformation. (Figure 26). The Editor Tool is open. (Figure 27)

EU Calibration Tool continued

After entering the name and clicking OK, the EU Calibration Editor tool is opened. The user successively enters an input voltage value, the output EU value that voltage maps to, and clicks the 'Add' button. At least 2 points must be entered. A 2-point transformation defines a straight-line (linear) transformation; more points can be entered to define a polynomial transformation of arbitrary order.

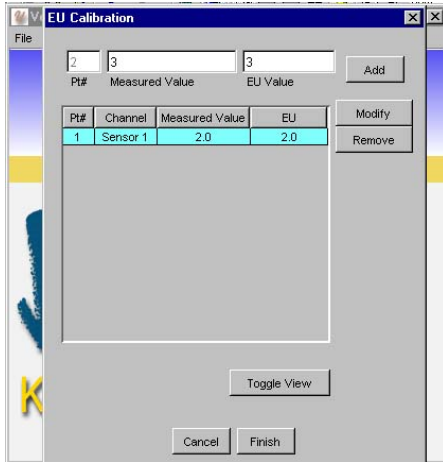

Figure 28. Enter Point 1

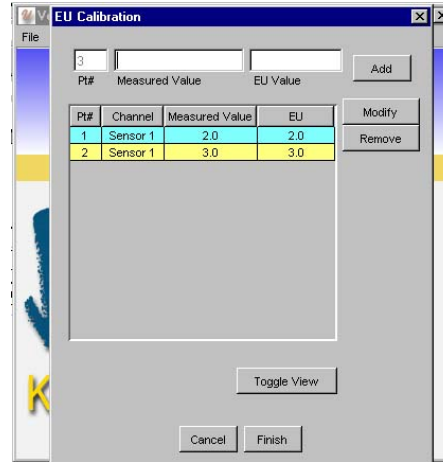

Figure 29. Enter Point 2

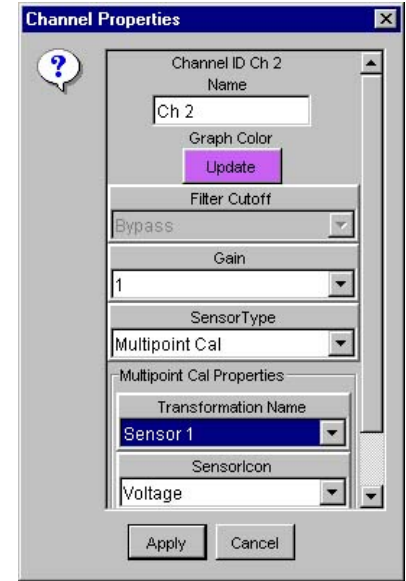

Figure 30. Select New Sensor in Channel Properties

EU Calibration Tool continued

For this example, a linear (2 point) transformation will be defined such that the output is doubled. Any 2 points on the straight line of slope 2 intercept of 0 could be chosen; the point (1,2) will be first (figure 27).

After the point (1,2) is entered and the add button is clicked, the first point is entered in the form, and the editor is ready for the 2nd point, which in this case will be (2,4) (Figure 28).

After the second point (2,4) is entered and the 'Add' button clicked, we are ready to end by clicking the 'Finish' button (Figure 29).

The transformation can now be applied to any channel by bringing up the Channel Property Chooser dialog for the channel, changing its Sensor Type to 'Multipoint Cal', and then choosing the desired transformation (Figure 30).

Note: If using more than a 10 point transformation, you will not be able to view data with the KineticSystems Viewer. The KineticSystems Viewer can only handle data with up to 10 calibration points (a ninth order polynomial). All other functions do not limit the number of points.

Glossary

10BaseT	An Ethernet connection capable of transmitting up to 10Mbps (10,000,000 bits per second)
ADC	Analog to Digital Converter – a device that converts analog signals such as voltage to digital numbers
CompactFlash®	A very small removable mass storage device.
Configuration	All the settings under which the data acquisition will be made - channel gains, filtering, sample rate, the conditions under which the session will start and stop, etc.
Crossover Cable	A special type of Ethernet cable used to directly connect 2 computers.
DAQ	Data Acquisition Device
Dialog	A window that pops up on a computer screen to prompt the user to enter something or select something from a list of choices.
Ethernet	A computer network architecture which specifies the connectors, cables and protocol for 2 or more computers to exchange information

Glossary, continued

EU Calibration	EU calibration transforms raw data from a sensor to a final result in appropriate units according to a <i>curve</i> specified. The curve is expressed as a finite set of points, entered into the EU Editor by the user.
Filter	A mechanism to remove unwanted signals (such as noise) from the input.
Gain	A mechanism to amplify low level signals so that they are more accurately measured
Hub	A device used to connect multiple computers to a network, much the way an extension cord is used to connect multiple appliances to a single electrical outlet.
IP Address	Internet Protocol Address – a set of four 3-digit numbers that uniquely identify a device on an internet
Isothermal Reference	A measurement of the temperature of the cabling and connectors connecting to a <i>thermocouple</i> . The temperature of the cabling and connectors must be taken into account when reading data from a thermocouple
LED	Light Emitting Diode – small lamp on front panel
PC	Personal Computer

Glossary, continued

Peer-to-peer Cable	Same as <i>Crossover Cable</i>
Sampling Rate	The rate at which a sensor's measurement is converted into a digital number. The mathematical reciprocal of the sampling rate is the time in seconds between each sample.
SCSI	Small Computer Systems Interface – standard 68 pin connector
Standalone Mode	In Standalone Mode, the DAQ432/464 can be triggered externally and collect data for a given duration without being connected to any computer
Synchronized	A configuration is <i>synchronized</i> when it has been successfully Imported or Exported. Synchronization indicates that the settings in the configuration match those on the data acquisition hardware. Synchronization can be determined via the Connection/Synchronization Indicator on the Operations Panel.

Glossary, continued

Target Platform	While data is being collected, it can be stored to any one of a number of <i>target platforms</i> . Most common are 'local' meaning the local PC, or <i>Compact Flash</i> , the storage media on the DAQ432/464 itself.
TCP/IP	Transmission Control Protocol/Internet Protocol - A protocol used by different computers to exchange information with each other
Thermocouple	An electrical device that measures temperature as a voltage.
Trigger	A signal which indicates data collection should start
TTL	Transistor-Transistor-Logic – Standard digital circuitry where inputs and outputs are limited to the range of 0 to 5 volts; signals less than 1.5 volts are 'false', while signals greater than 3.5 volts are 'true'
VersaDAQ	The <i>VersaDAQ</i> software package controls the DAQ432/464

Technical Support and Warranty

DynamicSignals warrants its standard hardware products to be free of defects in workmanship and materials for a period of one year from the date of shipment to the original end user. DynamicSignals warrants its software products to conform to the software description applicable at the time of purchase for a period of ninety days from the date of shipment. Products purchased for resale by DynamicSignals carry the original equipment manufacturer's warranty.

DynamicSignals will, at its option, either repair or replace products that prove to be defective in materials or workmanship during the warranty period.

Transportation charges for shipping products to DynamicSignals are prepaid by the purchaser, while charges for returning the repaired product to the purchaser, if located in the United States, are paid by DynamicSignals. Return shipments are made by UPS, where available, unless the purchaser requests a premium method of shipment at his expense. The selected carrier is not the agent of DynamicSignals, and DynamicSignals assumes no liability relating to the services provided by the carrier.

The product warranty may vary outside the United States or Switzerland and does not include shipping, customs clearance or any other charges. Consult your local authorized representative for more information regarding specific warranty coverage and shipping details.

Product specifications and descriptions in this document subject to change without notice.

DynamicSignals specifically makes no warranty of fitness for a particular purpose or any other warranty either expressed or implied, except as is expressly set forth herein. This warranty does not cover product failures created by unauthorized modifications, product misuse or improper installation.

Products are not accepted for credit or exchange without prior written approval. If it is necessary to return a product for repair replacement or exchange, a Return Authorization (RA) Number must first be obtained from the Repair Service Center before shipping the product to DynamicSignals.

Please take the following steps if you are having a problem and feel you may need to return a product for service:

- ❑ Contact DynamicSignals and discuss the problem with a Technical Service Engineer.
- ❑ Obtain a Return Authorization (RA) Number.
- ❑ Initiate a purchase order for the estimated repair charge if the product is out of warranty.
- ❑ Include with the product a description of the problem and the name of the technical contact person at your facility.
- ❑ Ship the product prepaid with the RA Number marked on the outside of the package to:

DynamicSignals, LLC
Repair Service Center
900 North State Street
Lockport, IL 60441

Telephone: (815) 838-0005
Fax: (815) 838-4424

Ways to contact us:



DynamicSignals, LLC
900 N. State Street
Lockport, IL 60441-2200



Phone: (800) DATA NOW (1-800-328-2669)
(815) 838-0005
Fax: (815) 838-4424



E-mail: mkt-info@kscorp.com
tech-serv@kscorp.com
sales@kscorp.com

Web: www.kscorp.com

Feedback

The purpose of this manual is to provide you with the information you need to make the DAQ as easy as possible to understand and use. It is very important that the information is accurate, understandable and accessible. To help us continue to make this manual as “user friendly” as possible, we hope you will fill out this form and Fax it back to us at (815) 838 0095. Or mail a copy to DynamicSignals, LLC 900 N. State, Lockport, IL 60441. Your input is very valuable.

Please rate each of the following.

The information in this manual is:

	Yes									No
Accurate	10	9	8	7	6	5	4	3	2	1
Readable	10	9	8	7	6	5	4	3	2	1
Easy to find	10	9	8	7	6	5	4	3	2	1
Well organized	10	9	8	7	6	5	4	3	2	1
Sufficient	10	9	8	7	6	5	4	3	2	1

52

We would appreciate receiving any thoughts you have about how we can improve this user's manual:

(Include additional sheets if needed)

Name

Company

Phone